

WELCOME

## CERN Courier – digital edition

Welcome to the digital edition of the September/October 2019 issue of *CERN Courier*.

During the final decade of the 20th century, the Large Electron Positron collider (LEP) took a scalpel to the subatomic world. Its four experiments – ALEPH, DELPHI, L3 and OPAL – turned high-energy particle physics into a precision science, firmly establishing the existence of electroweak radiative corrections and constraining key Standard Model parameters. One of LEP's most important legacies is more mundane: the 26.7 km-circumference tunnel that it bequeathed to the LHC. Today at CERN, 30 years after LEP's first results, heavy machinery is once again carving out rock in the name of fundamental research. This month's cover image captures major civil-engineering works that have been taking place at points 1 and 5 (ATLAS and CMS) of the LHC for the past year to create the additional tunnels, shafts and service halls required for the high-luminosity LHC. Particle physics doesn't need new tunnels very often, and proposals for a 100 km circular collider to follow the LHC have attracted the interest of civil engineers around the world. The geological, environmental and civil-engineering studies undertaken during the past five years as part of CERN's Future Circular Collider study, in addition to similar studies for a possible Compact Linear Collider up to 50 km long, demonstrate the state of the art in tunnel design and construction methods.

Also in this issue: a record field for an advanced niobium-tin accelerator dipole magnet; tensions in the Hubble constant; reports on EPS-HEP and other conferences; the ProtonMail success story; strengthening theoretical physics in southeastern Europe; and much more.

To sign up to the new-issue alert, please visit:

<http://comms.iop.org/k/iop/cerncourier>

To subscribe to the magazine, please visit:

<https://cerncourier.com/p/about-cern-courier>

EDITOR: MATTHEW CHALMERS, CERN  
DIGITAL EDITION CREATED BY IOP PUBLISHING

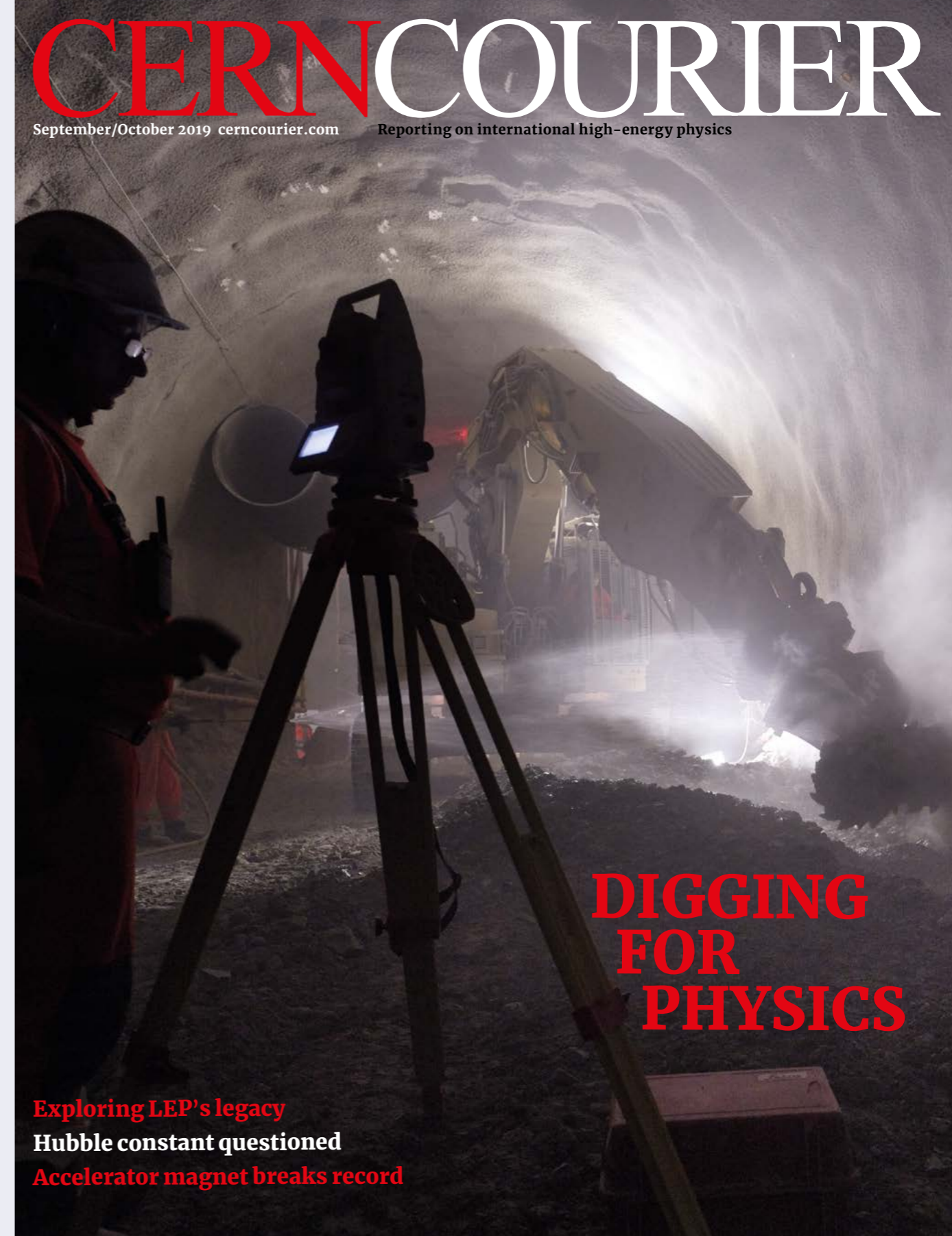

## DIGGING FOR PHYSICS

Exploring LEP's legacy

Hubble constant questioned

Accelerator magnet breaks record



## It's Time for a New Generation of Power Solutions!

FOR RESISTIVE AND SUPERCONDUCTING MAGNETS

Digital Output Control Precision Current Measurements  
Bipolar and Unipolar Power Converters  
Fast Connectivity Waveform Generation  
Embedded Linux OS Magnetic Load Protections  
Extreme Stability



**CAENels**  
Gear For Science  
FIRST PHYSICS.  
NOW INDUSTRY

**CT-BOX**  
ALL-IN-ONE CURRENT MEASUREMENT AND CALIBRATION SYSTEM

**EASY-DRIVER**  
DIGITAL BIPOLAR POWER SUPPLY AT AN INCREDIBLE PRICE

**FAST-PS-M**  
DIGITAL MONOPOLAR FAST POWER SUPPLY SERIES

**FAST-PS**  
DIGITAL BIPOLAR FAST POWER SUPPLY SERIES

**FAST-PS-1K5**  
1.5 kW DIGITAL BIPOLAR FAST POWER SUPPLY SERIES

**NGPS**  
10 kW HIGH STABILITY CURRENT AND VOLTAGE POWER SUPPLY

### CT-BOX

**All-In-One Current Measurement and Calibration System**  
Up to  $\pm 1.000$  A, 1 ppm/K TC, 100 ksp/s Data-Logger and Oscilloscope  
CT-Viewer software included with Ethernet, Serial and USB

### EASY-DRIVER

**$\pm 5$  A and  $\pm 10$  A /  $\pm 20$  V Bipolar Power Supply Series**  
Full-Bipolar operation, Digital Control Loop, Ethernet Connectivity  
Device supported by Visual Easy-Driver software

### FAST-PS-M

**Digital Monopolar Power Supplies - up to 100 A**  
High-Precision Monopolar Power Converters with Gigabit Ethernet  
Embedded Linux OS, device supported by Visual PS software

### FAST-PS

**Digital Bipolar Power Supplies - up to  $\pm 30$  A and  $\pm 80$  V**  
Full-Bipolar, Digital Control Loop, High-Bandwidth, 10/100/1000 Ethernet  
Embedded Linux OS, device supported by Visual PS software

### FAST-PS-1K5

**Digital Bipolar Power Supplies - up to  $\pm 100$  A and  $\pm 100$  V**  
1.500 W, Paralleling via SFP/SFP+, 1 ppm/K TC, 10/100/1000 Ethernet  
Embedded Linux OS, device supported by Visual PS software

### NGPS

**High-Stability 10-kW Power Supply - 200 A / 50 V**  
Digital Control Loop, Paralleling via SFP/SFP+, 10/100/1000 Ethernet  
Embedded Linux OS, device supported by Visual PS software



www.caenels.com

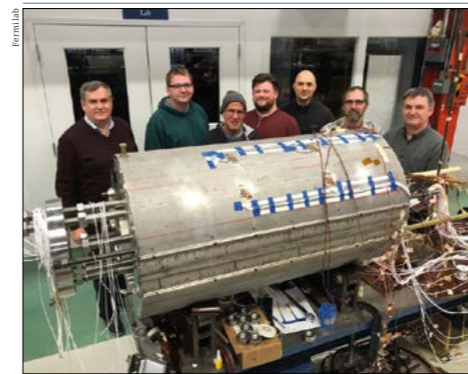

**Dipole development** US researchers have set a record for accelerator-magnet field strength. **7**



**Life at LEP** Accelerator physicists combined acumen with grit at a collider that transformed the field. **39**



**Hubble discrepancy** Nobel-laureate Adam Riess discusses the accelerating expansion of the universe. **47**

## NEWS

### ANALYSIS

Record dipole field  
• Astroparticle-theory centre • Breakthrough Prize for Supergravity  
• CERN and ESA join forces • MedAustron • Galaxy simulation • Cloud computing. **7**

### ENERGY FRONTIERS

CMS revisits rare and beautiful decays  
• Bottomonium elliptic-flow no-show  
• ATLAS pursues Higgs properties • LHCb chases charged-lepton flavour violation. **15**

### FIELD NOTES

EPS-HEP looks ahead  
• Higgs hunting  
• Between desert and swampland • Humboldt Kolleg • Cold-atom interferometry • FCC week • Strangeness in Quark Matter • Muon g-2. **19**

## PEOPLE

### CAREERS

**From SUSY to the boardroom**  
ProtonMail's founders left academia with the goal of making e-mail account holders the client rather than the product. **53**

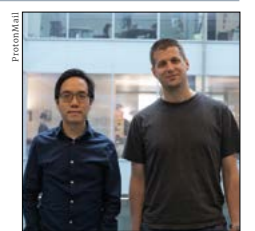

## FEATURES



**TUNNEL ENGINEERING**  
**Tunneling for physics**  
The civil engineering underpinning proposals for a future collider. **26**

**TUNNEL ENGINEERING**  
**Tunneling for physics**  
The civil engineering underpinning proposals for a future collider. **26**

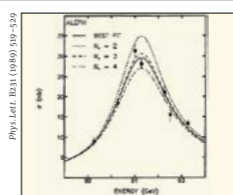

**LEP'S PHYSICS LEGACY**  
**LEP's electroweak leap**  
30 years ago, ALEPH, DELPHI, L3 and OPAL embarked upon a physics tour de force. **32**

**LEP'S PHYSICS LEGACY**  
**LEP's electroweak leap**  
30 years ago, ALEPH, DELPHI, L3 and OPAL embarked upon a physics tour de force. **32**

**THE STORY OF LEP**  
**The greatest lepton collider**  
Steve Myers tells LEP's story from conception to its emotional final day. **39**

## OPINION

### VIEWPOINT

**Building Balkan bridges in theory**  
European support is vital to build capacity in southeastern Europe. **45**

### INTERVIEW

**Grappling with dark energy**  
Adam Riess discusses discrepancies in the Hubble constant. **47**

### REVIEWS

**The cutting edge of cancer research**  
The Physics of Cancer  
• CERN and the Higgs Boson • Subatomic Desire. **51**

## DEPARTMENTS



**On the cover:**  
A road-header at point 5 in August, preparing for the high-luminosity LHC upgrade. (M.Brice/CERN.) **26**

FROM THE EDITOR	5
NEWS DIGEST	13
APPOINTMENTS & AWARDS	56
RECRUITMENT	58
BACKGROUND	62



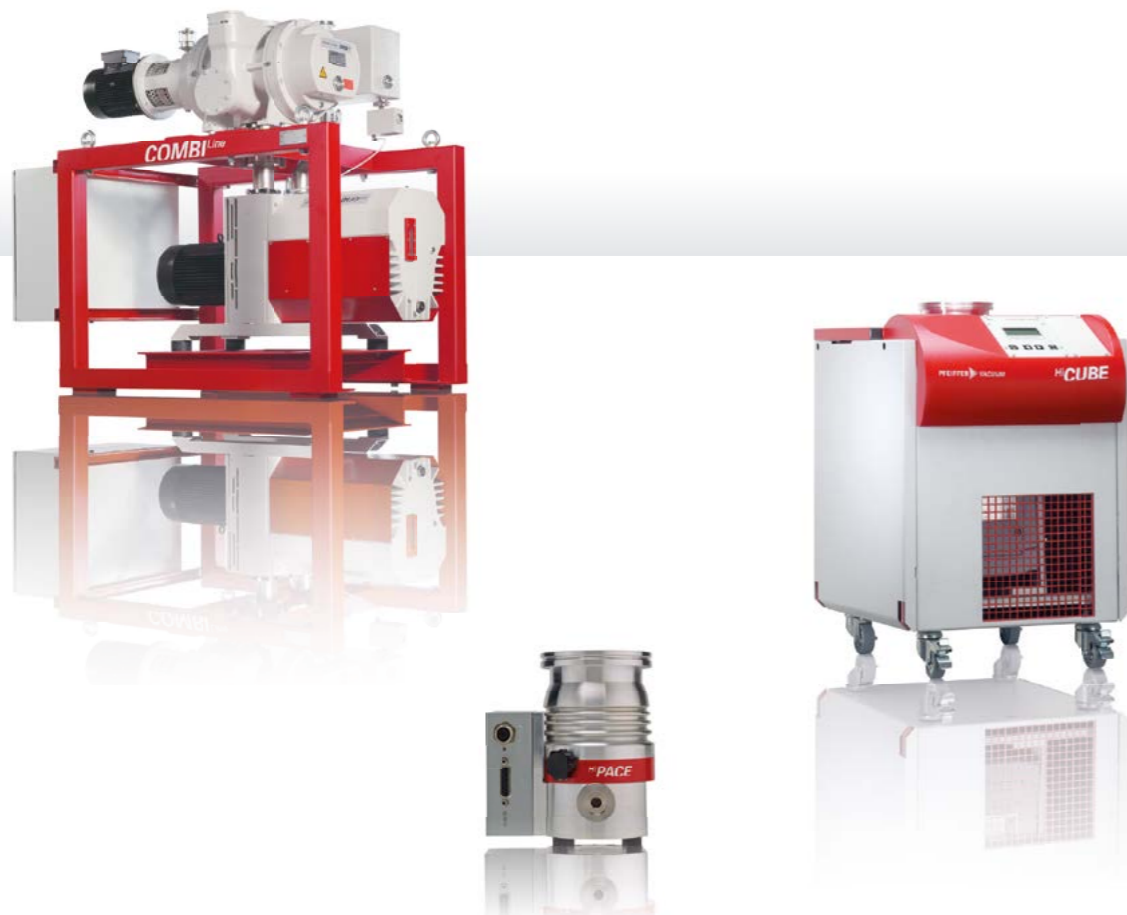

# VACUUM SOLUTIONS FROM A SINGLE SOURCE

Pfeiffer Vacuum is proud to have been a supplier of innovative and customized vacuum solutions to the particle accelerator community for more than 50 years. Our complete product portfolio for vacuum technology, our focus on competent and specialized advice supported by robust and reliable service, makes Pfeiffer Vacuum the partner of choice for the analytical and research communities worldwide.

- Pumps for vacuum generation down to UHV
- Vacuum measurement and analysis equipment
- Leak detectors and integrity test systems
- Vacuum components and chambers
- Pumping stations and customized solutions

Are you looking for a perfect vacuum solution? Please contact us:  
**Pfeiffer Vacuum (Schweiz) AG** · T +41 44 444 22 55 · F +41 44 444 22 66 · info@pfeiffer-vacuum.ch · www.pfeiffer-vacuum.com

## FROM THE EDITOR

### Boring matters



**Matthew Chalmers**  
Editor

During the final decade of the 20th century, the Large Electron Positron collider (LEP) took a scalpel to the subatomic world. Its four experiments – ALEPH, DELPHI, L3 and OPAL – turned high-energy particle physics into a precision science, firmly establishing the existence of electroweak radiative corrections. LEP's programme determined the number of neutrino families to be three, observed the running of the QCD coupling constant and severely constrained key Standard Model parameters, to name a few highlights (see p32). The machine broke new ground in the scale of projects in high-energy physics, and enjoys a proud place in the memories of those who worked on it (p39). One of LEP's most important legacies, however, is the 26.7 km-circumference tunnel that it bequeathed to the LHC. Without it, the rich seam of physics that is the exploration of the Higgs sector might still be buried.

Today at CERN, 30 years after LEP's first results, heavy machinery is once again carving out rock in the name of fundamental research. Since June 2018, major civil engineering works have been taking place at points 1 and 5 (ATLAS and CMS) of the LHC to make way for the high-luminosity LHC. Each site requires a new shaft of 80 m deep, a service hall to house cryogenic and other equipment, a 300 m-long tunnel for electrical equipment and four 50 m service tunnels that will connect the new structures to the accelerator tunnel. By the time the underground structures are completed in 2021, a total of around 100,000 m<sup>3</sup> of earth will have been excavated.

**One of LEP's most important legacies is its 26.7 km-circumference tunnel**

Particle physics doesn't need to dig new tunnels very often. Proposals for a 100 km circular collider to follow the LHC have therefore attracted the interest of civil engineers and even tech entrepreneurs around the world. The geological, environmental and civil engineering studies undertaken during the past five years as part of CERN's Future Circular Collider study (FCC), in addition to similar studies for a possible Compact Linear Collider up to 50 km long, demonstrate the state of the art in tunnel design and construction methods (p26). Were the FCC to go ahead, then just as the LEP tunnel under-



**Heroic** The LEP tunneling crew in January 1987 having completed the arc from point 2 to point 3 with only 1 cm of difference.

pinned a highly successful research programme spanning almost 50 years (and perhaps even longer), the FCC's lepton- and subsequent hadron-collider modes would serve particle physicists to at least the end of the 21st century. Sensing the opportunity, China is drawing up plans for a similar programme, benefitting from lower construction costs compared to Europe, but requiring associated infrastructure to be built from scratch. As for the machines that might one day occupy these fantastic tunnels, researchers in the US have recently demonstrated a record field for an advanced niobium-tin accelerator dipole magnet (p7).

Elsewhere in this issue, we explore tensions in the Hubble constant, report on EPS-HEP and other conferences (p19), describe the ProtonMail success story (p53), look at ways to strengthen theoretical physics in southeastern Europe (p45), and more. Finally, don't forget to browse the new *cerncourier.com*, where articles will be published on an ongoing basis.

#### Reporting on international high-energy physics

CERN Courier is distributed to governments, institutes and laboratories affiliated with CERN, and to individual subscribers. It is published six times per year. The views expressed are not necessarily those of the CERN management.

**Editor**  
Matthew Chalmers  
**Associate editor**  
Mark Rayner  
**Archive contributor**  
Peggie Rimmer  
**Astrowatch contributor**  
Merlin Kole  
**E-mail**  
cern.courier@cern.ch

**Advisory board**  
Peter Jenni  
Christine Sutton  
Claude Amstler  
Philippe Bloch  
Roger Forty  
Mike Lamont  
Matthew McCullough

**Laboratory correspondents:**  
**Argonne National Laboratory** Tom LeCompte  
**Brookhaven National Laboratory** Achim Franz  
**Cornell University** D G Cassel  
**DESY Laboratory** Till Mundzeck  
**Enrico Fermi Centre** Guido Piragino  
**Fermilab** Kurt Riesselmann  
**Forschungszentrum Jülich** Markus Buescher  
**GSI Darmstadt** I Peter  
**IHEP, Beijing** Lijun Guo  
**IHEP, Serpukhov** Yu Ryabov

**INFN Antonella Varaschin**  
**Jefferson Laboratory** Kandice Carter  
**JINR Dubna** B Starchenko  
**KEK National Laboratory** Hajime Hikino  
**Lawrence Berkeley Laboratory** Spencer Klein  
**Los Alamos National Lab** Rajan Gupta  
**NCSL** Ken Kingery  
**Nikhef** Robert Fleischer  
**Novosibirsk Institute** S Eidelman  
**Orsay Laboratory** Anne-Marie Lutz  
**PSI Laboratory** P-R Kettle  
**Saclay Laboratory** Elisabeth Locci  
**UK STFC** Jane Binks

**SLAC National Accelerator Laboratory** Melinda Baker  
**SNOLAB** Samantha Kuula  
**TRIUMF Laboratory** Marcello Pavan  
**Produced for CERN by IOP Publishing Ltd** Temple Circus, Temple Way, Bristol BS1 6HG, UK Tel +44 (0)117 929 7481

**Head of B2B and journalism** Jo Allen  
**B2B commercial operations manager** Ed Jost  
**Art director** Andrew Giaquinto

**Production editor** Ruth Leopold  
**Technical illustrator** Alison Tovey  
**Advertising sales** Tom Houlden  
**Recruitment sales** Chris Thomas  
**Advertisement production** Katie Graham  
**Marketing and circulation** Angela Gage  
Laura Gillham

**Advertising**  
Tel +44 (0)117 930 1026 (for UK/Europe display advertising) or +44 (0)117 930 1164 (for recruitment)

advertising; e-mail sales@cerncourier.com

**General distribution**  
Courier Addressage, CERN, 1211 Geneva 23, Switzerland; e-mail courier-addressage@cern.ch

**Published by** CERN, 1211 Geneva 23, Switzerland Tel +41 (0) 22 767 61 11

**Printed by** Warners (Midlands) plc, Bourne, Lincolnshire, UK

© 2019 CERN ISSN 0304-288X



## ACCELERATORS

## Advanced dipole sets high-field record

Researchers in the US have demonstrated an advanced accelerator dipole magnet with a field of 14.1 T – the highest ever achieved for such a device at an operational temperature of 4.5 K. The milestone is the work of the US Magnet Development Program (MDP), which includes Fermilab, Lawrence Berkeley National Laboratory (LBNL), the National High-Field Magnetic Field Laboratory and Brookhaven National Laboratory. The MDP's "cos-theta 1" (MDPCT1) dipole, made from Nb<sub>3</sub>Sn superconductor, beats the previous record of 13.8 T at 4.5 K achieved by LBNL magnet "HD2" that has stood for more than 10 years, and follows the 14.6 T at 1.9 K (13.9 T at 4.5 K) reached by "FRESCA 2" at CERN in 2018, which was built as a superconducting-cable test station, rather than an accelerator magnet. Together with other recent advances in accelerator magnets in Europe and elsewhere, the result sends a positive signal for the feasibility of next-generation hadron colliders.

The MDP was established in 2016 by the US Department of Energy to develop magnets that operate as closely as possible to the fundamental limits of superconducting materials while minimising the need for magnet training. The programme aims to integrate domestic accelerator-magnet R&D and position the US in the technology development for future high-energy proton-proton colliders, including a possible 100 km-circumference facility at CERN under study by the Future Circular Collider (FCC) collaboration. In addition to the baseline design of MDPCT1, other design options for such a machine have been studied and will be tested in the coming years.

"The goal for this first magnet test was to limit the coil mechanical pre-load to a safe level, sufficient to produce a 14 T field in the magnet aperture," explains MDPCT1 project leader Alexander Zlobin of Fermilab. "This goal was achieved after a short magnet training at 1.9 K: in the last quench at 4.5 K the magnet reached 14.1 T. Following this successful test the magnet pre-stress will be increased to reach its design limit of 15 T."

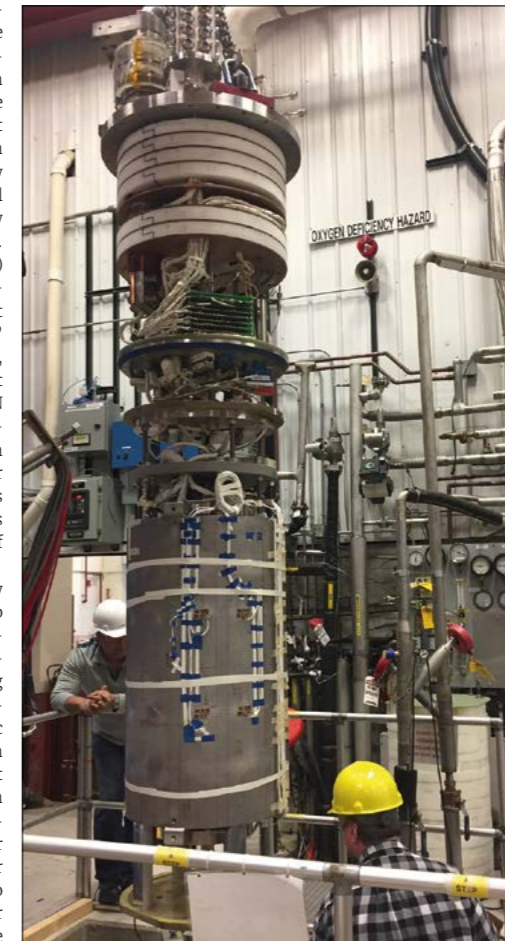
**Magnetic moment**

Installation of the MDP "cos-theta 1" dipole magnet into a test cryostat at Fermilab.

**The result sends a positive signal for the feasibility of next-generation hadron colliders**

The development of high-field superconducting accelerator magnets has received a strong boost from high-energy physics in the past decades. The current state of the art is the LHC dipole magnets, which operate at 1.9 K to produce a field of around 8 T, enabling proton-proton collisions at an energy of 13 TeV. Exploring higher energies, up to 100 TeV at a possible future circular collider, requires higher magnetic fields to steer the more energetic beams. The goal is to double the field strength compared to the LHC dipole magnets, reaching up to 16 T, which calls for innovative magnet design and a different superconductor compared to the Nb-Ti used in the LHC. Currently, Nb<sub>3</sub>Sn (niobium tin) is being explored as a viable candidate for reaching this goal. High-temperature superconductors, such as REBCO, MgB<sub>2</sub>, and iron-based materials, are also being studied.

**HL-LHC first**

The first accelerator magnets to use Nb<sub>3</sub>Sn technology are the 11 T dipole magnets and the final-focusing magnets under development for the high luminosity LHC (HL-LHC), which will be installed around the interaction points. But the FCC would require more than 5000 superconducting dipoles grouped for powering in series and operating continuously over long time periods. A number of critical aspects underlie the design, cost-effective manufacturing and reliable operation of 16 T dipole magnets in future colliders. Among the targets for the Nb<sub>3</sub>Sn conductor is a critical current density of 1500 A/mm<sup>2</sup> at 16 T and 4.2 K – almost a 50% increase compared to the current state of the art. In addition to the conductor, developing an industry-adapted design for 16 T dipoles and other accelerator magnets with higher performance presents a major challenge.

The FCC collaboration has launched a rigorous R&D programme towards 16 T magnets. Key components are the global Nb<sub>3</sub>Sn conductor development programme, featuring a network of academic institutes and industrial partners, and the 16 T magnet-design work package supported by the EU-funded ▽

pco.

if there is  
no second chance:  
**sensitivity & speed**  
**@ highest precision**

**PCO** – the most versatile sCMOS  
camera portfolio on the market

**pco.edge 5.5**

- 100 fps @ 2556 x 2160 pixel and 16 bit digitization
- 30 000 : 1 intra scene dynamic
- rolling / global / global reset shutter modes
- 10G FOL data interface
- **pco.sdk** for Windows and Linux

**pco.edge 4.2 bi**

- up to 95% quantum efficiency
- bi**<sup>back</sup>  
illuminated
- compact design
- uv version available
- deep cooled to -25 °C
- **pco.sdk** for Windows and Linux

**pco.dicam C1**

- intensified sCMOS technology
- high resolution 2048 x 2048 pixel
- minimum exposure time 4 ns with 25 mm image intensifier
- double image mode with 300 ns interframing time
- multi channel option with 13.8 million fps
- 10G FOL data interface
- **pco.sdk** for Windows and Linux

pco.de



EuroCirCol project. This is now being followed by a 16 T short-model programme aiming at constructing model magnets with several partners worldwide such as the US MDP. Unit lengths of Nb<sub>3</sub>Sn wires with performance at least comparable to that of the HL-LHC conductor have already been produced by industry and cabled at CERN, while, at Fermilab, multi-filamentary wire produced with an internal oxidation process has already exceeded the critical current density target for the FCC – just two examples of many recent advances in this area. EuroCirCol, which officially wound up this year (see p23), has also

**The FCC conductor development targets are very challenging**

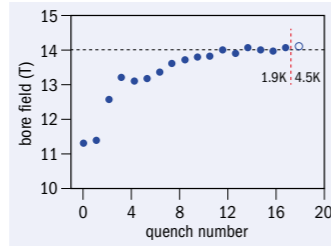

**Fig 1.** Training quench history for the MDPCT1 demonstrator magnet at Fermilab, showing the 14.1 T field attained at 4.5 K.

enabled a design and cost model for the magnets of FCC, demonstrating the feasibility of Nb<sub>3</sub>Sn technology.

“The enthusiasm of the worldwide superconductor community and the achievements are impressive,” says Amalia Ballarino, leader of the conductor activity at CERN. “The FCC conductor development targets are very challenging. The demonstration of a 14 T field in a dipole accelerator magnet and the possibility of reaching the target critical current density in R&D wires are milestones in the history of Nb<sub>3</sub>Sn conductor and a reassuring achievement for the FCC magnet development programme.”

**THEORY**

## A new centre for astroparticle theory

On 10 July, CERN and the Astroparticle Physics European Consortium (APPEC) founded a new research centre for astroparticle physics theory called EuCAPT. Led by an international steering committee comprising 12 theorists from institutes in France, Portugal, Spain, Sweden, Germany, the Netherlands, Italy, Switzerland and the UK, and from CERN, EuCAPT aims to coordinate and promote theoretical physics in the fields of astroparticle physics and cosmology in Europe.

Astroparticle physics is undergoing a phase of profound transformation, explains inaugural EuCAPT director Gianfranco Bertone, who is spokesperson of the Centre for Gravitation and Astroparticle Physics at the University of Amsterdam. “We have recently obtained extraordinary results such as the discovery of high-energy cosmic neutrinos with IceCube, the direct detection of gravitational waves with LIGO and Virgo, and we have witnessed the birth of multi-messenger astrophysics. Yet we have formidable challenges ahead of us: understanding the nature of dark matter and dark energy, elucidating the origin of cosmic rays, understanding the matter-antimatter asymmetry problem, and so on. These are highly interdisciplinary problems that have ramifications in cosmology, particle, and astroparticle physics, and that are best addressed by a strong and diverse community of scientists.”

The construction of experimental astroparticle facilities is coordinated by APPEC, but until now there was no Europe-wide coordination of theoretical activities, says Bertone. “We want to be open and inclusive, and we hope that all



**Merging minds** Gian Giudice (head of CERN-TH), Teresa Montaruli (APPEC chair), Eckhard Elsen (CERN director for research and computing) and Job de Kleuver (APPEC secretary-general) with the new agreement.

interested scientists will feel welcome to join this new initiative.” On a practical level, EuCAPT aims to coordinate scientific and training activities, help researchers attract adequate resources for their projects, and promote a stimulating and open environment in which young scientists can thrive. CERN will act as the central hub of the consortium for the first five years.

It is not a coincidence that CERN has been chosen as the central hub of EuCAPT, says Gian Giudice, head of CERN’s theory department. “The research that we are

**These are highly interdisciplinary problems**

doing at CERN-TH is an exploration of the possible links between physics at the smallest and largest scales. Creating a collaborative network among European research centres in astroparticle physics and cosmology will boost activities in these fields and foster dialogue with particle physics,” he says. “Dark matter, dark energy, inflation and the origin of large-scale structures are big questions regarding the universe. But there are good hints that suggest that their explanation has to be looked for in the domain of particle physics.”

**AWARD**

## Supergravity attracts Special Breakthrough Prize

On 6 August, theorists Sergio Ferrara of CERN, Dan Freedman of MIT and Stanford University, and Peter van Nieuwenhuizen of Stony Brook University were awarded a \$3 million Special Breakthrough Prize in Fundamental Physics for their 1976 invention of supergravity.

Supergravity marries general relativity with supersymmetry – an important step in the quest for a unified theory of gravity and the strong and electroweak interactions. At the time, it was not obvious how this could be done. During a short period lasting from autumn 1975 to spring the following year, Ferrara, Freedman and van Nieuwenhuizen succeeded, with the help of state-of-the-art computers, in producing a supersymmetric theory that included the gravitino as the supersymmetric partner of the graviton. The trio published their paper in June 1976.

Chair of the prize selection committee, Edward Witten of the Institute for Advanced Study in Princeton, says of the achievement: “The discovery of supergravity was the beginning of including quantum variables in describing the dynamics of space-time. It is quite striking that Einstein’s equations admit the generalisation that we know as supergravity.”

Despite numerous searches at ever higher energies during the past decades, no supersymmetric particles have been observed. But supergravity has still had an enormous influence on theoretical physics – especially on string theory, of which supergravity is a low-energy manifestation (CERN Courier January/February 2017 p41). Supergravity was a crucial ingredient in the 1984 proof by Michael Green and John Schwarz that string theory is mathematically consistent, and it was also instrumental in the M-theory

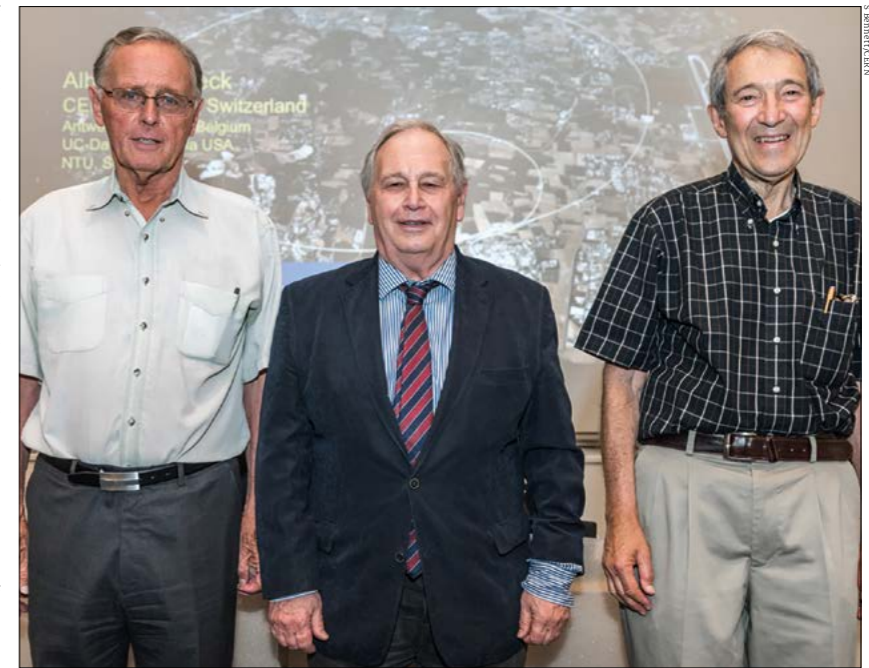

string unification by Witten in 1995. It played a role in Andrew Strominger and Cumrun Vafa’s 1996 derivation of the Bekenstein-Hawking entropy for quantum black holes, and is also important in the holographic AdS/CFT duality discovered by Juan Maldacena in 1997.

A Special Breakthrough Prize can be awarded at any time in recognition of an extraordinary scientific achievement. Previous winners of the physics prize are: the late Stephen Hawking; seven physicists whose leadership led to the discovery of the Higgs boson at CERN;

**Super trio** Peter van Nieuwenhuizen, Sergio Ferrara and Dan Freedman (left to right) at CERN in 2016 on the occasion of supergravity’s 40th anniversary.

the LIGO and Virgo collaborations for the detection of gravitational waves; and Jocelyn Bell Burnell for the discovery of pulsars. The new laureates, along with the winners of the Breakthrough Prize in Life Sciences and in Mathematics, will receive their awards at a ceremony on 3 November.

“This award comes as a complete surprise,” says Ferrara. “Supergravity is an amazing thing because it extends general relativity to a higher symmetry – the dream of Einstein – but none of us expected this.”

**FACILITIES**

## CERN and ESA join forces in harsh environments

Strengthening connections between particle physics and related disciplines, CERN signed a collaboration agreement with the European Space Agency (ESA) on 11 July to address the challenges of operating equipment in harsh radiation environments. Such environments are found in both particle-physics facilities and outer space, and the agreement identifies

**Europa** A recent project at CERN evaluated the effects of radiation on electronics for the Jupiter Icy Moons Explorer (JUICE) mission.

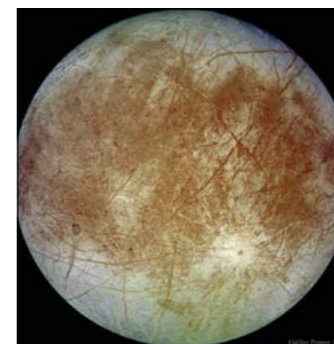

several high-priority projects, including: high-energy electron tests; high-penetration heavy-ion tests; assessment of commercial components and modules; radiation-hard and radiation-tolerant components and modules; radiation detectors, monitors and dosimeters; and simulation tools for radiation effects. Important preliminary results have already been achieved in some areas, including high-energy electron tests of electronics for the Jupiter Icy Moons Explorer (JUICE) mission performed at CERN’s CLEAR/VESPER facility.

## NEWS ANALYSIS

## MEDICAL PHYSICS

# MedAustron debuts carbon-ion therapy

MedAustron, an advanced hadron-therapy centre in Austria, has treated its first patient with carbon ions. The medical milestone, which took place on 2 July, elevates the particle-physics-linked facility to the ranks of only six centres worldwide that can combat tumours with both protons and carbon ions.

When protons and carbon ions strike biological material, they deposit a large dose in a small and well-targeted volume, reducing damage to healthy tissue surrounding a tumour and thereby reducing the risk of side effects. While proton therapy has been successfully used at MedAustron since December 2016, treating more than 400 cancer patients so far, carbon-ion therapy opens up new opportunities to target tumours that were previously difficult or impossible to treat. Carbon ions are biologically more effective than protons and therefore allow a higher biological dose to be administered to the tumour.

MedAustron's accelerator complex is based on the CERN-led Proton Ion Medical Machine Study, the design subsequently developed by CERN, the TERA Foundation, INFN in Italy and the CNAO Foundation (*CERN Courier* January/February 2018 p25). Substantial help was also provided by the Paul Scherrer Institute, in particular for the gantry and beam-delivery designs. The MedAustron system comprises an injector (where ions from



**Heavy treatment**  
The MedAustron proton/carbon-ion synchrotron, which was constructed in collaboration with CERN and others.

three ion sources are pre-accelerated by a linear accelerator), a synchrotron, a high-energy beam transport system to deliver the beam to various beam ports, and a medical front-end, which controls the irradiation process and covers all safety aspects. Certified as a medical product, the accelerator provides proton and carbon ion beams with a penetration depth of about up to 37 cm in water-equivalent tissue, and is able to deliver carbon-ions with 255 different energies ranging from 120 to 400 MeV with maximum intensities of up to  $10^{10}$  ions per extracted beam pulse.

"The first successful carbon-ion treatment unveils MedAustron's full potential for cancer treatment," says Michael Benedikt of CERN, who coordinated CERN's contributions to the project. "The realisation of MedAustron, through the collaboration with CERN for

the construction of the accelerator facility, is an excellent example of large-scale technology transfer from fundamental research to societal applications."

Particle therapy with carbon ions was first used in a dedicated medical facility in Japan in 1994, and a total of almost 30,000 patients worldwide have since been treated with this method. Initially, treatment with carbon ions at MedAustron will focus on tumours in the head and neck region, and at the base of the skull. But the spectrum will be continuously expanded to include other tumour types.

"Irradiation with carbon ions makes it possible to maintain both the physical functions and the quality of life of patients, even with very complicated tumours," says Piero Fossati, scientific and clinical director of MedAustron's carbon-ion programme.

field values, while dark-blue regions correspond to a very small scalar fields, i.e. regions where screening is active and the theory behaves like general relativity. The right-half of the image shows the gas density with stars over-plotted. The simulation, which was based on a total of 12 simulations for different model parameters and resolutions and required a total runtime of about 2.5 million core-hours, shows that spiral galaxies like our Milky Way could still form even with different laws of gravity. "Our research definitely does not mean that general relativity is wrong, but it does show that it does not have to be the only way to explain gravity's role in the evolution of the universe," says lead author Christian Arnold of Durham University's Institute for Computational Cosmology. (*Nature Astronomy*; arXiv:1907.02977.)

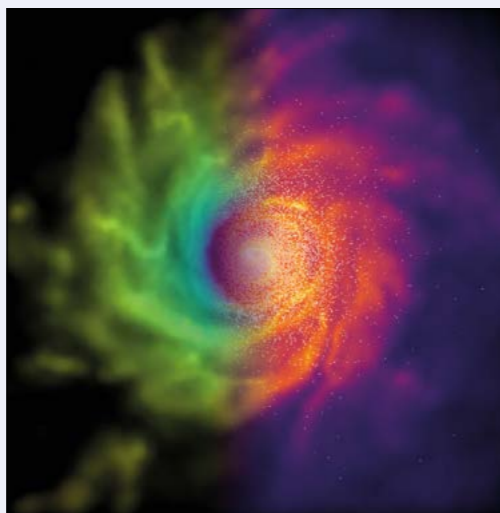

## ALTERNATIVE GRAVITY

## Galaxies thrive on new physics

This supercomputer-generated image of a galaxy suggests that general relativity might not be the only way to explain how gravity works. Theorists at Durham University in the UK simulated the universe using hydrodynamical simulations based on "f(R) gravity" – in which a scalar field enhances gravitational forces in low-density regions (such as the outer parts of a galaxy) but is screened by the so-called chameleon mechanism in high-density environments such as our solar system. The left-half of the image shows the scalar field of the theory: bright yellow regions correspond to large scalar-

## COMPUTING

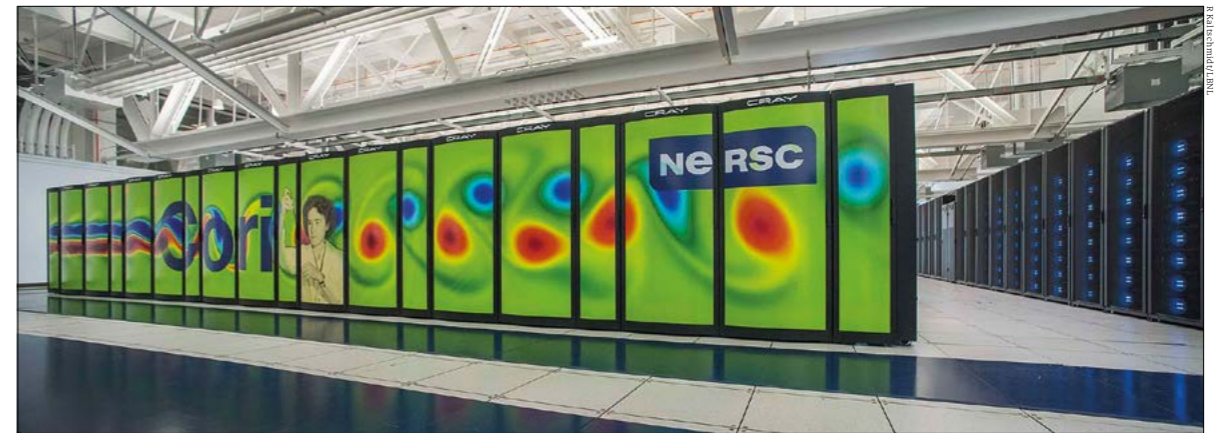

**Paradigm shift** Researchers on the NOvA and CMS experiments have already used HEPCloud to run jobs on the US National Energy Research Scientific Computing Center at Berkeley.

# Cloud services take off in the US and Europe

Fermilab has announced the launch of HEPCloud, a step towards a new computing paradigm in particle physics to deal with the vast quantities of data pouring in from existing and future facilities. The aim is to allow researchers to "rent" high-performance computing centres and commercial clouds at times of peak demand, thus reducing the costs of providing computing capacity. Similar projects are also gaining pace in Europe.

"Traditionally, we would buy enough computers for peak capacity and put them in our local data centre to cover our needs," says Fermilab's Panagiotis Spentzouris, one of HEPCloud's drivers. "However, the needs of experiments are not steady. They have peaks and valleys, so you want an elastic facility." All Fermilab experiments will soon submit jobs to HEPCloud, which provides a uniform interface so that researchers don't need expert knowledge about where and how best to run their jobs.

The idea dates back to 2014, when Spentzouris and Fermilab colleague Lothar Bauerdick assessed the volumes of data coming from Fermilab's neutrino programme and the US participation in CERN's Large Hadron Collider (LHC) experiments. The first demonstration of HEPCloud on a significant scale was in February 2016, when the CMS experiment used it to achieve about 60,000 cores on the Amazon cloud, AWS, and, later that year, to run 160,000 cores using Google Cloud Services. Most recently in May 2018, the NOvA team at Fermilab

was able to execute around 2 million hardware threads at a supercomputer at the National Energy Research Scientific Computing Center of the US Department of Energy's Office of Science. HEPCloud project members now plan to enable experiments to use the state-of-the-art supercomputing facilities run by the DOE's Advanced Scientific Computing Research programme at Argonne and Oak Ridge national laboratories.

## Europe's Helix Nebula

CERN is leading a similar project in Europe called the Helix Nebula Science Cloud (HNSciCloud). Launched in 2016 and supported by the European Union (EU), it builds on work initiated by EIROforum in 2010 and aims to bridge cloud computing and open science. Working with IT contractors, HNSciCloud members have so far developed three prototype platforms and made them accessible to experts for testing.

"The HNSciCloud pre-commercial procurement finished in December 2018 having shown the integration of commercial cloud services from several providers (including Exoscale and T-Systems) with CERN's in-house capacity in order to serve the needs of the LHC experiments as well as use cases from life sciences, astronomy, proton and neutron science," explains project leader Bob Jones of CERN. "The results and lessons learned are contributing to the implementation of the European Open Science Cloud where a common

procurement framework is being developed in the context of the new OCRE [Open Clouds for Research Environments] project."

The European Open Science Cloud, an EU-funded initiative started in 2015, aims to bring efficiencies and make European research data more sharable and reusable. To help European research infrastructures move towards to this open-science future, a €16 million EU project called ESCAPE (European Science Cluster of Astronomy & Particle Physics ESFR) was launched in February. The 3.5 year-long project led by the CNRS will see 31 facilities in astronomy and particle physics collaborate on cloud computing and data science, including CERN, the European Southern Observatory, the Cherenkov Telescope Array, KM3NeT and the Square Kilometre Array (SKA).

In the context of ESCAPE, CERN is leading the effort of prototyping and implementing a FAIR (Findable, Accessible, Interoperable, Reproducible) data infrastructure based on open-source software, explains Simone Campana of CERN, who is deputy project leader of the Worldwide LHC Computing Grid (WLCG). "This work complements the WLCG R&D activity in the area of data organisation, management and access in preparation for the HL-LHC. In fact, the computing activities of the CERN experiments at HL-LHC and other initiatives such as SKA will be very similar in scale, and will likely coexist on a shared infrastructure."

**The aim is to allow researchers to rent high-performance computing centres**

# Best™ Cyclotron Systems

Best Cyclotron Systems provides 15/20/25/30/35/70 MeV Proton Cyclotrons as well as 35 & 70 MeV Multi-Particle (Alpha, Deuteron & Proton) Cyclotrons

- Currents from 100uA to 1000uA (or higher) depending on the particle beam are available on all BCS cyclotrons
- Best 20u to 25 and 30u to 35 are fully upgradeable on site

Cyclotron	Energy (MeV)	Isotopes Produced
Best 15	15	<sup>18</sup> F, <sup>99m</sup> Tc, <sup>11</sup> C, <sup>13</sup> N, <sup>15</sup> O, <sup>64</sup> Cu, <sup>67</sup> Ga, <sup>124</sup> I, <sup>103</sup> Pd
Best 20u/25	20, 25-15	Best 15 + <sup>123</sup> I, <sup>111</sup> In, <sup>68</sup> Ge/ <sup>68</sup> Ga
Best 30u (Upgradeable)	30	Best 15 + <sup>123</sup> I, <sup>111</sup> In, <sup>68</sup> Ge/ <sup>68</sup> Ga
Best 35	35-15	Greater production of Best 15, 20u/25 isotopes plus <sup>201</sup> Tl, <sup>81</sup> Rb/ <sup>81</sup> Kr
Best 70	70-35	<sup>82</sup> Sr/ <sup>82</sup> Rb, <sup>123</sup> I, <sup>67</sup> Cu, <sup>81</sup> Kr + research



Installation of Best 70 MeV Cyclotron at INFN, Legnaro, Italy

## Best™ ABT Molecular Imaging

The BG-75 Biomarker Generator is a revolutionary development in radio-pharmaceutical production that delivers a single or batch dose of <sup>18</sup>F-FDG, and additional advanced <sup>18</sup>F biomarkers on demand. The system provides integration of all components needed to produce and qualify PET biomarkers into a single, self-contained system that occupies a fraction of the space required by conventional solutions, simplifying the implementation of PET.



TeamBest Companies © 2019

## Best™ Particle Therapy

400 MeV Rapid Cycling Medical Synchrotron for Proton-to-Carbon Heavy Ion Therapy:

- Intrinsically small beams facilitating beam delivery with precision
- Small beam sizes – small magnets, light gantries – smaller footprint
- Highly efficient single turn extraction
- Efficient extraction – less shielding
- Flexibility – heavy ion beam therapy (protons and/or carbon), beam delivery modalities



\* Best iRCMS is under development and not available for sale currently.

# NEWS DIGEST



M87\* has more angular momentum than any other measured object.

### Black-hole image constrains ultra-light dark matter

Brookhaven's Hooman Davoudiasl and Peter Denton have used the recent Event Horizon Telescope image of supermassive black hole M87\* to disfavour "fuzzy" models of ultra-light boson dark matter (DM) with masses of the order of a few  $10^{-21}$  eV (*Phys. Rev. Lett.* **123** 021102). The inferred mass, spin and age of the black hole are incompatible with the existence of such fuzzy DM given the principle of superradiance, whereby quantum fluctuations deplete the angular momentum of a rotating black hole by populating a cloud of bosons around it. The effect depends only on the bosons' mass, and does not presuppose any non-gravitational interactions. Future measurements of M87\* and other spinning supermassive BHs have the potential to exclude the entire parameter space for fuzzy DM.

### Neutrino number revised up

LEP's signature measurement of the number of neutrino families  $N_\nu = 2.9840 \pm 0.0082$ , obtained 30 years ago (see p32), will be revised even closer to three thanks to new calculations of LEP's integrated luminosity. Inspired by design studies for future  $e^+e^-$  colliders, Georgios Voutsinas of CERN and co-workers have improved the calculation of the beam-beam effect, whereby electromagnetic forces between dense bunches of electrons and positrons degrade the beam quality. They conclude that LEP's true integrated luminosity is about 0.1% higher than previously thought (arXiv:1908.01704). The only precision electroweak observable affected is expected to be the peak Z cross

section (the key ingredient in  $N_\nu$ ), according to co-author Patrick Janot of CERN. "I have a hard time imagining any other LEP measurement that would be significantly affected by this small change," he says, "but we will certainly look."

### IceCube gets first major upgrade

Seven strings of optical modules will be added to the bottom-centre region of the IceCube neutrino observatory at the South Pole, after US, Japanese and German institutions fully funded the detector's first major upgrade. The new strings will be placed within a highly instrumented central region of IceCube called DeepCore, but with even more closely spaced and tightly packed sensors, reducing IceCube's neutrino-energy threshold to a few GeV. The primary goals are to measure neutrino oscillations to tau neutrinos and reduce systematics relating to optical scattering and absorption in the ice. Researchers also hope to shed light on the neutrino mass hierarchy and sterile neutrinos. The 700 or so new optical modules are two to three times more sensitive than the 5160 sensors already embedded in the ice, and will pave the way for IceCube-Gen2 – a planned extension with 10 times greater volume.



Carrie McGivern of Fermilab inspects ANNIE phototubes.

### ANNIE prepares for action

The Accelerator-Neutrino-Neutron Interaction Experiment (ANNIE) is now installed and being commissioned at Fermilab, in preparation for beam this autumn. ANNIE will measure neutron yields from neutrino-nucleus interactions in water. As well as testing the performance of newly commercialised

Large-Area Picosecond Photo-detectors (LAPPDs), ANNIE will dissolve gadolinium salts in the water to test an ingenious method for neutron detection that was pioneered by the EGADS experiment in Japan: neutrons are expected to excite the gadolinium nuclei, which should then emit observable photons after a short delay. This technique will also be used at Super-Kamiokande, to help distinguish neutrinos and antineutrinos in CP-violation studies.

### THz accelerators build up STEAM

DESY physicists have taken a critical step forward in demonstrating the feasibility of miniature accelerators powered by terahertz radiation, by delivering a record 70keV at a peak accelerating gradient of 200MV/m (*Optica* **6** 872). The feat – the first time a THz accelerator has doubled the energy of a beam – was accomplished using two Segmented THz Electron Accelerator and Manipulator (STEAM) devices. The first shortens the electron bunches from 0.3 to 0.1mm so that they may be coherently accelerated in the second. THz-driven electron acceleration has recently emerged as a promising approach for developing compact X-ray sources for materials science and medical imaging. Miniaturisation by means of scaling accelerators to THz frequencies promises higher acceleration gradients, better synchronisation and significant decreases in cost and size.

### Largest CCD array complete

Brookhaven National Laboratory has marked the end of a 16-year project to construct the world's biggest charge-coupled-device array. The 3.2 gigapixel sensor will be used in the camera of the Large Synoptic Survey Telescope (LSST), which is currently under construction in Chile. Also boasting a mirror the width of a tennis court, the detector will record 15TB of data per night, with each image capturing a solid angle equivalent to 40 full moons. LSST's goals encompass mapping galaxies for the study of dark energy and dark matter, providing a

minute-level alert for astrophysical events, improving the catalogue of Milky Way objects by a factor of 1000, and detecting potentially hazardous near-earth objects. First observations are scheduled for 2022.

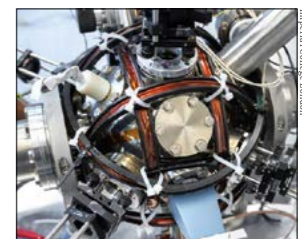

Cold atom interferometry was used to place limits on dark energy models.

### Table-top experiment constrains dark energy

Physicists at Imperial College London and The University of Nottingham have placed stringent limits on the "chameleon" and "symmetron" theories of modified gravity (*Phys. Rev. Lett.* **123** 061102). Given the empirical success of the weak-field limit of general relativity, these dark-energy models propose screening mechanisms whereby the new forces are weaker when there is more matter around – the opposite of how gravity behaves. The UK team used an interferometer to measure the acceleration of an atom toward a marble-sized test mass inside a high-vacuum chamber where the forces should be unscreened, but found nothing untoward.

### Beauty baryons discovered

The LHCb Collaboration has discovered two new resonances in the combined Run 1 and Run 2  $\Lambda_b^0 \pi^+ \pi^-$  invariant mass spectrum. The new states, dubbed  $\Lambda_b(6146)^0$  and  $\Lambda_b(6152)^0$ , join  $\Lambda_b(5912)^0$  and  $\Lambda_b(5920)^0$ , which were discovered by the collaboration in 2012. The masses are consistent with theoretical predictions for  $\Lambda_b(1D)^0$  states with  $J^P = 3/2^+$  and  $5/2^+$ , but their interpretation as other excited beauty baryons, such as neutral  $\Sigma_b^0$  states, cannot be excluded. The ongoing studies provide detailed tests of the quark model.



TMD

...the power in microwaves!



# ULTRA AVAILABLE AMPLIFIERS FOR ACCELERATOR & MEDICAL APPLICATIONS

TMD in collaboration with Rosatom - NIITFA is now able to offer revolutionary, ultra-available RF solid state amplifiers for scientific and medical applications.

Innovative power combining and control system results in:

- Ultra-compact systems, typically one 19" rack / 100 kW (pulse)
- CW / Pulse Systems, long pulse
- Modular Solid State architecture, compact modules (<10 kg)
- Highly Maintainable with **Hot Swap** capability
- Wall Plug efficiency competitive with tube technology (55% demonstrated)
- Highly robust to VSWR mismatch
- High MTBF and Low MTTR
- No loss of power from any single element failure
- High efficiency enhances reliability
- Frequencies available from 20 MHz to 1.3 GHz
- MW power capability

### Applications:

- Synchrotrons, LINACs for scientific, experimentation/particle physics and Spallation systems
- Medical therapy equipment
- Cyclotrons for radioisotope production
- Option to upgrade existing systems

### Other Products:

- High Power, Very Low Phase Noise TWT Amplifiers
- Brazed UHV components
- Electron Guns

For more information on our leading edge technology email us at [wecare@tmd.co.uk](mailto:wecare@tmd.co.uk) or visit [www.tmd.co.uk](http://www.tmd.co.uk)



# ENERGY FRONTIERS

Reports from the Large Hadron Collider experiments

CMS

## CMS revisits rare and beautiful decays

The  $B_s$  meson is a bound state of a strange quark and a beauty antiquark – as such it possesses both beauty and strangeness. For many years the search for its extremely rare decay to a  $\mu^+\mu^-$  pair was a holy grail of particle physics, because of its sensitivity to theories that extend the Standard Model (SM). The SM predicts the decay rate for  $B_s \rightarrow \mu^+\mu^-$  to be only about 3.6 parts per billion (ppb). Its lighter cousin, the  $B^0$ , which is made from a down quark and a beauty antiquark, has an even lower predicted branching fraction for decays to a  $\mu^+\mu^-$  pair of 0.1 ppb. If beyond-the-SM particles exist, however, the predictions could be modified by their presence, giving the decays sensitivity to new physics that rivals and might even exceed that of direct searches.

It took more than a quarter of a century of extensive effort to establish  $B_s \rightarrow \mu^+\mu^-$ , and the first observation was presented in 2013, in a joint publication by the CMS and LHCb collaborations based on LHC Run 1 data. The same paper reported evidence for  $B^0 \rightarrow \mu^+\mu^-$  with a significance of three standard deviations, however, this signal has not subsequently been confirmed by CMS, LHCb or ATLAS analyses. A new CMS Run 2 analysis now looks set to bolster interest in these intriguing decays.

The CMS collaboration has updated its 2013 analysis with higher centre-of-mass-energy Run 2 data from 2016, permitting an observation of  $B_s \rightarrow \mu^+\mu^-$  with a significance of 5.6 standard deviations (figure 1). The results are consistent with the latest results from ATLAS and LHCb, and while no significant deviation from the SM is observed by any of the experiments, all three decay rates are found to lie slightly below the SM prediction. The slight deficit is not significant, but the trend is intriguing because it could be related to so-called flavour anomalies recently observed by the LHCb experiment in other rare decays of B mesons (CERN Courier May/June p9). This makes the new CMS measurement even more exciting. The new analysis showed no sign of  $B^0 \rightarrow \mu^+\mu^-$ , and a stringent 95% confidence limit of less than 0.36 ppb

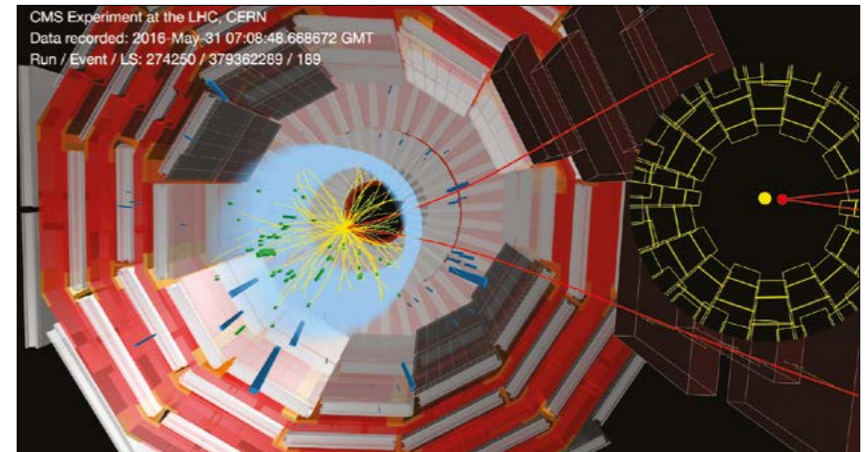

**Beauty and strangeness** Two muons (red) emerge from a  $B_s \rightarrow \mu\mu$  decay candidate in the CMS Run 2 data. The inset shows the displacement of the decay vertex from the collision point (yellow).

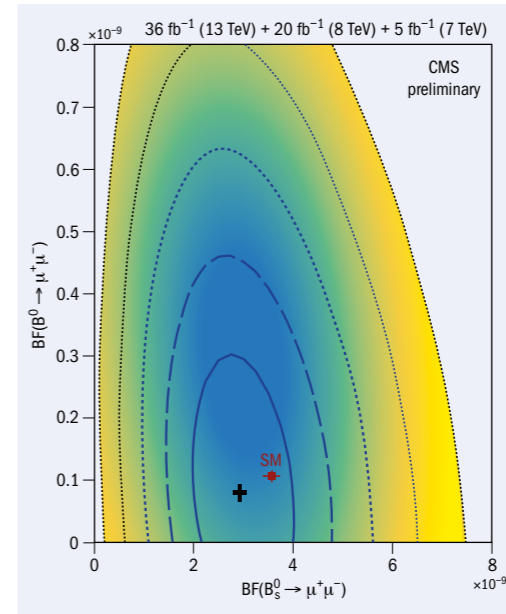

**Fig. 1.** Probability contours representing the simultaneous measurement of the relative probabilities for  $B_s \rightarrow \mu\mu$  and  $B^0 \rightarrow \mu\mu$  decays. The contours correspond to one to five standard deviations, and the red point indicates the SM predictions.

was set on its rate.

CMS also managed to measure the effective lifetime of the  $B_s$  meson using the several dozen  $B_s \rightarrow \mu^+\mu^-$  decay events that were observed. The interest in measuring this lifetime is that, just as for the branching fraction, new physics might alter its value from the SM expectation. This measurement yielded a lifetime of about 1.7 ps, consistent with the SM. The measured CMS value is also consistent with the only other such lifetime measurement, performed by LHCb.

With three times more Run 2 data yet to be analysed by CMS, the next update – based on the full Run 1 and Run 2 datasets – may shed more light on this fascinating corner of physics, and move us closer to the ultimate goal, which is the observation of the  $B^0 \rightarrow \mu^+\mu^-$  decays.

### Further reading

- CMS Collaboration 2019 CMS-PAS-BPH-16-004.
- CMS and LHCb collaborations 2015 *Nature* **522** 68.
- LHCb Collaboration 2017 *Phys. Rev. Lett.* **118** 191801.
- ATLAS Collaboration 2019 *J. High Energy Phys.* **04** 098.





## ALICE

## Bottomonium elliptic-flow no-show

High-energy heavy-ion collisions at the LHC give rise to a deconfined system of quarks and gluons called the quark-gluon plasma (QGP). One of its most striking features is the emergence of collective motion due to pressure gradients that develop at the centre. Direct experimental evidence for this collective motion is the observation of anisotropic flow, which translates the asymmetry of the initial geometry into a final-state momentum anisotropy. Its magnitude is quantified by harmonic coefficients  $v_n$  in a Fourier decomposition of the azimuthal distribution of particles. As a result of the almond-shaped geometry of the interaction volume, the largest contribution to the asymmetry is the second coefficient, or "elliptic flow",  $v_2$ .

A positive  $v_2$  has been measured for a large variety of particles, from pions, protons and strange hadrons up to the heavier  $J/\psi$  meson. The latter is a curious case as quarkonia such as  $J/\psi$  are bound states of a heavy quark (charm or bottom) and its antiquark (CERN Courier December 2017 p11). Quarkonia constitute interesting probes of the QGP because heavy-quark pairs are produced early and experience the full evolution of the collision. In heavy-ion collisions at the LHC, charmonia, such as the  $J/\psi$ , dissociate due to screening from free colour charges in the QGP, and regenerate by the recombination of thermal-

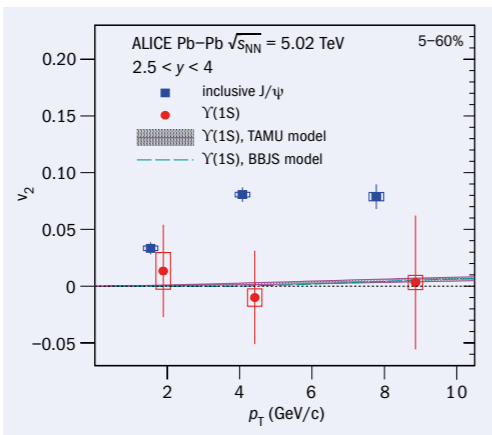

**Fig. 1.**  $Y(1S)$  elliptic flow versus  $p_T$  for the 5–60% centrality interval. (Centrality estimates the degree of overlap between the two colliding nuclei, with 0% corresponding to head-on collisions.) The measurements are compared with inclusive  $J/\psi$  and predictions from theoretical models of non-central Pb–Pb collisions.

**Bottomonia are the first hadrons that do not seem to flow in heavy-ion collisions at the LHC**

ised charm quarks. More massive still, and having a higher binding energy than charmonium, the dissociation of bottomonium  $Y(1S)$  is expected to be limited to the early stage of the collision when the temperature of the surrounding QGP medium is high. Its regeneration is not expected to be significant because of the

small number of available bottom quarks.

The ALICE collaboration recently reported the first measurement of the elliptic flow of the  $Y(1S)$  meson in lead-lead (Pb–Pb) collisions using the full Pb–Pb data set of LHC Run 2 (figure 1). The measured values of the  $Y(1S)$   $v_2$  are small and consistent with zero, making bottomonia the first hadrons that do not seem to flow in heavy-ion collisions at the LHC. Compared to the measured  $v_2$  of inclusive  $J/\psi$  in the same centrality and  $p_T$  intervals, the  $v_2$  of  $Y(1S)$  is lower by 2.6 standard deviations. The results are also consistent with the small, positive values predicted by models that include no or small regeneration of bottomonia by the recombination of bottom quarks interacting in the QGP.

These observations, in combination with earlier measurements of the suppression of  $Y(1S)$  and  $J/\psi$ , support the scenario in which charmonia dissociate and reform in the QGP, while bottomonia are dominantly dissociated at early stages of the collisions. Future datasets, to be collected during LHC runs 3 and 4 after a major upgrade of the ALICE detector, will significantly improve the quality of the present measurements.

## Further reading

ALICE Collaboration 2019 arXiv:1907.03169.

## ATLAS

## Run 2 data set pins down Higgs-boson properties

The LHC completed its Run 2 operations in December 2018, delivering a large dataset of proton–proton collisions at a centre-of-mass energy of 13 TeV. The ATLAS detector maintained a high level of readiness and performance throughout Run 2, resulting in  $139 \text{ fb}^{-1}$  of data for physics analyses.

An increasingly consistent picture of the properties of the Higgs boson is being drawn in light of the Run 2 data. This is thanks to a wide range of measurements, and particularly through the establishment of its couplings with third-generation quarks following the observation of the  $H \rightarrow b\bar{b}$  decay and associated  $t\bar{t}H$  production.

The  $H \rightarrow \gamma\gamma$  and  $H \rightarrow ZZ^* \rightarrow 4\ell$  final states, where  $4\ell$  denotes  $4e$ ,  $2e2\mu$  or  $4\mu$ , provide clean experimental signatures that played a leading role in the discov-

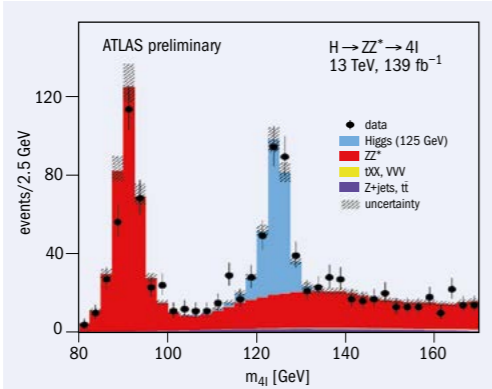

**Fig. 1.** Distribution of the invariant mass of the four leptons selected in the  $H \rightarrow ZZ^* \rightarrow 4\ell$  final state using the full Run 2 dataset. The Higgs boson corresponds to the excess of events at 125 GeV (light blue) over the non-resonant  $ZZ^*$  background (red).

ery of the Higgs boson, and are ideal for precision measurements that could reveal subtle effects from new physics. ATLAS presented updated results for these two channels using the full Run 2 dataset at the 2019 summer conferences.

Using improved identification and energy calibration of leptons, photons and jets, and new analysis techniques, a sample of about 210  $H \rightarrow ZZ^* \rightarrow 4\ell$  signal events (figure 1) and 6550  $H \rightarrow \gamma\gamma$  signal events were selected to perform a series of measurements. The properties of the Higgs boson are investigated by measuring inclusive, differential and per-production-mode cross sections that are sensitive to different modelling aspects.

In the  $4\ell$  channel, differential cross-section measurements are performed as a function of the transverse

momentum of the Higgs boson and the number of jets produced in association with it. The different production mechanisms of the Higgs boson are measured inclusively and in various regions of kinematic phase space, which are cleanly separated by neural networks.

In the high-statistics  $\gamma\gamma$  channel, differential cross sections are measured for a set of variables related to the Higgs boson kinematics, as well as the kinematics and multiplicity of jets produced in association with the Higgs boson. The measured distributions are used to constrain modified interactions of the Higgs boson with SM particles.

The measurements in both channels are found to be well described by the SM predictions. Their combination yields a total Higgs–production cross section of  $55.4 \pm 4.3 \text{ pb}$ , in agreement with the SM prediction of  $55.6 \pm 2.5 \text{ pb}$ .

## LHCb

## Chasing charged-lepton-flavour violation

Processes where the flavour of charged leptons is not conserved are undetectably rare in the Standard Model (SM). For neutral leptons, flavour violation is known to occur in neutrino oscillations, but charged-lepton-flavour violation (CLFV) is so suppressed that, if observed, it would provide indisputable evidence of physics beyond the SM.

The LHCb collaboration recently reported the results of searches for two CLFV decays,  $B^+ \rightarrow K^+ \mu^+ e^-$  and  $B^0 \rightarrow \tau^+ \mu^-$ , using  $3 \text{ fb}^{-1}$  of data collected in 2011 and 2012. The two decays provide complementary information as their final states involve charged leptons from different families, and both represent experimental challenges for LHCb. While the detector performance is excellent for muons, it is more difficult to reconstruct electrons and taus. The difficulty with electrons is related to energy losses via bremsstrahlung radiation. Meanwhile, the short-lived tau leptons are always reconstructed from their decay products, which include at least one neutrino, and thus part of the tau's energy is unavoidably lost. In both cases, the analyses are able to recover some of the lost information and improve the resolution by exploiting constraints on the kinematics and topology of the decay.

Neither search found a signal (figure 1), but thanks to these reconstruction techniques and the large quantity of B-meson

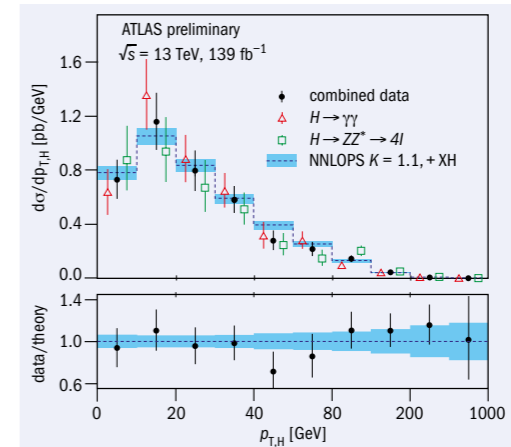

**Fig. 2.** Differential cross section for the transverse momentum of the Higgs boson as measured from the  $H \rightarrow ZZ^* \rightarrow 4\ell$  and  $H \rightarrow \gamma\gamma$  channels and their combination, compared to the SM prediction (light blue).

cross section (figure 2) has significantly improved in precision compared to earlier results. It is sensitive to the virtual processes governing the dominant Higgs–boson production through gluon fusion and to direct contributions from new physics.

Achieving 8% precision on the Higgs cross section is a significant step towards studying the electroweak symmetry breaking mechanism. Numerous additional measurements are being pursued by ATLAS in the Higgs–boson sector with the full Run 2 dataset to perform detailed tests of SM predictions and hunt for new phenomena.

## Further reading

ATLAS Collaboration 2019 ATLAS–CONF–2019–025.  
ATLAS Collaboration 2019 ATLAS–CONF–2019–029.  
ATLAS Collaboration 2019 ATLAS–CONF–2019–032.

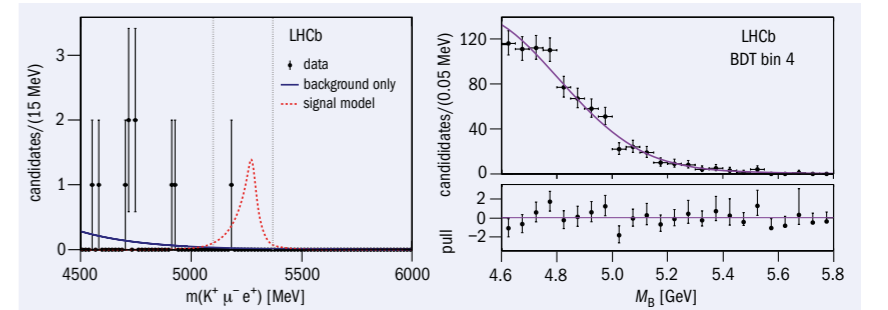

**Fig. 1.** Left: the invariant mass distribution of  $B^+ \rightarrow K^+ \mu^+ e^-$  candidates in Run 1 data, along with the fitted background (blue) and an illustration of the signal shape normalised to 10 events (dashed red). Right: the reconstructed mass distribution for  $B^0 \rightarrow \tau^+ \mu^-$  candidates in the highest-purity subsample, with the fit projection for the background-only hypothesis and normalised residuals.

decays recorded by the detector, LHCb has established the most stringent upper limits on the branching fractions of these decays:  $9.5 \times 10^{-9}$  for  $B^+ \rightarrow K^+ \mu^+ e^-$ ,  $8.8 \times 10^{-9}$  for  $B^+ \rightarrow K^+ \mu^+ e^-$ ,  $1.4 \times 10^{-5}$  for  $B^0 \rightarrow \tau^+ \mu^-$ , and  $4.2 \times 10^{-5}$  for  $B^0 \rightarrow \tau^+ \mu^-$  (all at the 95% confidence level). The latter is also the first ever limit on  $B^0 \rightarrow \tau^+ \mu^-$ .

CLFV decays of B-mesons are particularly interesting in light of recent flavour anomalies, whereby LHCb found hints that the decay rates for  $b \rightarrow s\mu^+\mu^-$  and  $b \rightarrow se^+e^-$  are not equal (CERN Courier May/June 2019 p33). While the anomalies are most suggestive of the violation of lepton flavour universality, several proposed

extensions to the SM that address them also predict CLFV, with branching ratios for  $B^+ \rightarrow K^+ \mu^+ e^-$  and  $B^0 \rightarrow \tau^+ \mu^-$ , which are within LHCb's reach. The latest LHCb results therefore impose strong new constraints on beyond-SM models. The analyses also open the door to further LHCb tests of CLFV by demonstrating the feasibility of searches for rare processes with final-state electrons and taus.

## Further reading

LHCb Collaboration LHCb–PAPER–2019–016.  
LHCb Collaboration LHCb–PAPER–2019–022.

**While the detector performance is excellent for muons, it is more difficult to reconstruct electrons and taus**

# Generic High Speed DAQ

Our ready-to-prototype generic high-speed DAQ solution is based on experience with different diagnostic and low-level control devices that we have integrated throughout the years.

The digitizer part of these applications is not in the domain or of interest to beam diagnostics or RF physicists. From a physicist's point of view, the most important part of the application is the analogue front end and signal processing of acquired ADC data, which is specific to each application. These can often be specific to the machine and can vary from institute to institute, which is why off-the-shelf solutions might not be adequate. The system avoids "reinventing the wheel" for every device based on a digitizer board, to prevent separate development of common parts and to provide a generic interface for devices throughout the accelerator.

Diagnostic devices such as BPMs, BCMs and low-level controls, for example LLRF, can all be considered to be digitizer boards with some custom FPGA processing and specific analogue front ends. Their underlying functionality is the same – gather some signals, process them and sometimes provide an output. All these applications thus require generic DAQ functionality, while each of them adds signal processing specific to the application.

The key properties of the solution are:

- Out of the box support of generic digitizer functionality (firmware, driver, library, screens).
- Ability to extend the FPGA core with application-specific code.
- Control system framework independent library allowing easy integration into any framework.
- Option for an application-specific analogue front end due to the concept of rear transition modules (RTMs) in MTCA.4 standard.

The system allows for immediate prototyping. Even if the user is not a software engineer, the setup provides basic building blocks that can be used to facilitate an iterative development procedure of physics-related algorithms without requiring daily services from control specialists.

If the user does not have FPGA programming experience, initial prototyping can simply be done by using the provided library and HMI screens.



The custom algorithm development process thus becomes more hardware/software independent, allowing physicists to develop independently of the control system group, with tools they know well (i.e. Matlab). The software/firmware architecture keeps the main processing core the same for all the applications. This reduces development and maintenance costs, and the number of different hardware that need to be kept in stock.

The common core for digitizer-related functionality is not the only aspect of these devices that can be generalized. Extra common interfaces, such as MPS, can be identified and added later.

## Architecture

Starting bottom up (from hardware), we have the firmware that provides support for generic digitizer functionality and leaves enough room for custom signal processing applications. The custom part can be added in addition to the digitizer functionality, keeping the basic core common for all applications.



Author  
**Urša Rojec**  
Control Systems  
Engineer  
Project Manager

One level above the firmware is the lowest software component – the kernel module. The kernel module implements DMA functionality, access to device registers and interrupt handling. All the functionality of the module is generic PCI Express communication and does not include DAQ-specific functionality. This keeps the complexity of the module to a minimum. By using the same kernel module in all the applications, we make sure that the code running in the kernel is well tested and stable.

The most complex part of the software stack is the user-space library which is written in C. By pushing all the complexity to the C library, we achieve two things:

1. The kernel module can stay the same for all the applications. This allows for a well-tested code running in the kernel, where bugs are typically hard to find and cause more inconveniences than in user space.
2. The board can be easily integrated into any control system framework. Since the main functionality is included in the library, the CS-specific applications only need to provide a link between the library and CS.

When application-specific processing is added to the FPGA, the library can be extended to provide access to the existing functionality.

The idea of a generic FPGA core for several devices is not new, but the MTCA.4 standard offers more flexibility due to the concept of rear transition modules (RTMs). By using RTMs, the same digitizer board can serve several applications by having a customized analogue front end. This also simplifies having items on stock, since the board can be turned into a BPM, BCM, etc by simply flashing the correct firmware.

The solution aims to minimize the time spent on integration of the board and provide a ready-to-prototype base system with supported generic DAQ functionality and a possibility to add custom signal processing cores to the FPGA.



Contact us:  
**Cosylab., Control System Laboratory**  
Tel +386 1 477 66 76  
Email info@cosylab.com  
Web www.cosylab.com

# FIELD NOTES

Reports from events, conferences and meetings

EUROPEAN PHYSICAL SOCIETY CONFERENCE ON HIGH-ENERGY PHYSICS

## Ghent event surveys future of the field

Almost 750 high-energy physicists met from 10–17 July in Ghent, Belgium, for the 2019 edition of EPS-HEP. The full scope of the field was put under a microscope by more than 500 parallel and plenary talks and a vibrant poster session. The ongoing update of the European Strategy for Particle Physics (ESPP) was a strong focus, and the conference began with a session jointly organised by the European Committee for Future Accelerators to seek further input from the community ahead of the publication of the ESPP briefing book in September.

The accepted view, explained ESPP secretary Halina Abramowicz, is that an electron-positron collider should succeed the Large Hadron Collider (LHC). The question is whether to build a linear collider that is extendable to higher energies, or a circular collider whose infrastructure could later be reused for a hadron collider. DESY's Christophe Grojean weighed up the merits of a Large Electron Positron collider (LEP)-style Z-pole run at a high-luminosity circular machine – a "tera-Z factory" – against the advantages of the polarised beams proposed at linear facilities, and questioned the value of polarisation to measurements of the Higgs boson at energies above 250 GeV. Furthermore, he said, sensitivities should be evaluated in light of the expected performance of the high-luminosity LHC (HL-LHC).

### Blue skies required

Presentations on accelerator and detector challenges emphasised the importance of sharing development between competing projects: while detector technology for an electron-positron machine could begin production within about five years, proposed hadron colliders require a technological leap in both radiation hardness and readout speed. CERN's Ariella Cattai expressed concern for excessive utilitarianism in detector development, with only 5% of R&D being blue-sky despite the historical success of this approach in developing TPC, RICH and silicon strip detectors, among others. She also pointed out that although 80% of R&D specialists believe their work has poten-

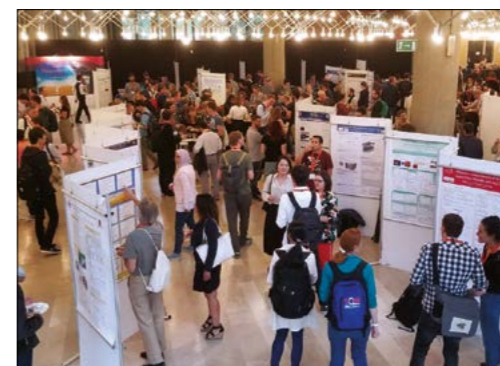

**Making connections**  
EPS-HEP participants size up the future of the field.

**The accepted view is that an electron-positron collider should succeed the LHC**

tial social outcomes, less than a third feel adequately supported to engage in technology transfer. Delegates agreed on the need for more recognition for those who undertake this crucial work. CERN's Graeme Stewart highlighted the similar plight of theorists developing event generators, whose work is often not adequately rewarded or supported. The field also needs to keep pace with computing developments outside the field, he said, by designing data models and code that are optimised for graphics-processing units rather than CPUs (central-processing units).

The beginning of the main EPS conference was dominated by impressive new results from ATLAS and CMS, as they begin to probe Higgs couplings to second-generation fermions, and as the experiments continue to search for new phenomena and rare processes. Several speakers noted that the LHC even has the potential to exceed LEP in precision electroweak physics: although the hadronic environment increases systematic uncertainties, deviations arising from beyond-Standard Model (SM) phenomena are expected to scale with the centre-of-mass energy squared. Giulia Zanderighi of the Max Planck Institute and Claude Duhr of CERN also highlighted the need to improve the precision of theoretical calculations if they are to match experimental precision by the end of the HL-LHC's run, showcasing work to extend next-to-next-to-leading order

(NNLO) calculations to two-to-three processes, and the latest moves to N<sup>2</sup>LO calculations.

The flavour-physics scene was updated with new SM-consistent constraints from Belle on the ratios R(D) and R(D\*), somewhat lessening the suggestion of lepton-universality violation in B-meson decays. With the advent of LHCb's full Run 2 dataset, the flavour anomalies will surely soon be confirmed or resolved. LHCb also presented new measurements of the gamma angle of the unitarity triangle, which show a mild 2 $\sigma$  tension between the values obtained from B<sup>+</sup> and B<sup>0</sup> decays. Meanwhile, long-baseline neutrino-oscillation experiments provided tantalising information on leptonic CP violation, with T2K data excluding CP conservation at 2 $\sigma$  irrespective of the neutrino mass hierarchy, and NOVA disavouring an inverted hierarchy of neutrino mass eigenstates at 1.9 $\sigma$ .

### Background checks

A refrain common to both collider and non-collider searches for dark-matter candidates was the need to eliminate backgrounds. A succession of talks scaled the 90 orders of magnitude in mass that dark-matter candidates might occupy. CERN's Kfir Blum explained that: "The problem with gravity is that it doesn't matter if you're a neutrino or a rhinoceros – if you sit on a geodesic you're going to move in the same way," making it difficult to infer the nature of dark matter with cosmological arguments. Nevertheless, he reported work on the recent black-hole image from the Event Horizon Telescope, which excludes some models of ultra-light dark matter (see p13). Above this, helioscopes such as CAST continue to encroach on the parameter space of QCD axions, while more novel haloscopes cut thin swathes down to low couplings in the 20 orders of magnitude of mass explored by searches for axion-like particles. Meanwhile, searches for WIMPs are sensitive to masses just beyond this, from 1 to 1000 GeV/c<sup>2</sup>. Carlos delos Heros of Uppsala University explained that experiments such as XENON1t are pushing close to ▷



the so-called neutrino floor, and advocated for the development of directional detection methods that can distinguish solar neutrinos from WIMPs, and plunge into what is rather a neutrino "swamp".

An exciting synergy between heavy-ion physics and gravitational waves was in evidence, with the two disparate approaches both now able to probe the equation of state of nuclear matter. Particular emphasis was placed on the need to marry the successful hydrodynamical and statistical description of ion-ion collisions with that used to describe proton-proton collisions, especially in the tricky proton-ion regime. These efforts are already bearing fruit in jet modelling. On the cosmological side, speakers reflected on the enduring

success of the  $\Lambda$ CDM model to describe the universe in just six parameters, with François Bouchet of the Institut d'Astrophysique de Paris declaring that "the magic of the cosmic microwave background is not dead", and explaining that Planck data have ruled out several models of inflation. Interdisciplinarity was also on display in reports on multi-messenger astronomy, with particular excitement reserved for the proposed European-led Einstein Telescope gravitational-wave observatory, which Marek Kowalski of DESY reported will most likely be built in either Italy or the Netherlands, and that will boast 10-times better sensitivity than current instruments.

This year's EPS prize ceremony rewarded the CDF and Do collaborations

**The magic of the cosmic microwave background is not dead**

for the discovery of the top quark, and the WMAP and Planck collaborations for their outstanding contributions to astroparticle physics and cosmology. Today's challenges are arguably even greater, and the spirit of EPS-HEP 2019 was to reject a false equivalence between physics being "new" and being beyond the SM. Participants' hunger for the technological innovation required to answer the many remaining open questions was matched by an openness to reconsider theoretical thinking on fine tuning and naturalness, and how these principles inform the further exploration of the field.

EPS-HEP 2021 will take place in Hamburg from 21-28 July.

Mark Rayner CERN.

### HIGGS HUNTING 2019

## Higgs hunters still hungry in Paris

The 10th Higgs Hunting workshop took place in Orsay and Paris from 29-31 July, attracting 110 physicists for lively discussions about recent results in the Higgs sector. The ATLAS and CMS collaborations presented Run 2 analyses with up to  $140 \text{ fb}^{-1}$  of data collected at a centre-of-mass energy of 13 TeV. The statistical uncertainty on some Higgs properties, such as the production cross section, has now been reduced by a factor three compared to Run 1. This puts some Higgs studies on the verge of being dominated by systematic uncertainties. By the end of the LHC's programme, measurements of the Higgs couplings to the photon, W, Z, gluon, tau lepton and top and bottom quarks are all expected to be dominated by theoretical rather than statistical or experimental uncertainties.

Several searches for additional Higgs bosons were presented. The general recipe here is to postulate a new field in addition to the Standard Model (SM) Higgs doublet, which in the minimal case yields a lone physical Higgs universally associated with the particle discovered at the LHC with a mass of 125 GeV in 2012. Adding a hypothetical additional Higgs doublet, however, as in the two Higgs doublet model, would yield five physical states: CP-even neutral Higgs bosons  $h$  and  $H$ , the CP-odd pseudoscalar  $A$ , and two charged Higgs bosons  $H^\pm$ ; the model would also bequeath three additional free parameters. Other models discussed at Higgs Hunting 2019 include the minimal and next-to-minimal supersymmetric SMs and extra Higgs states with doubly charged Higgs bosons. Anna Kaczmarska



from ATLAS and Suzanne Gascon-Shotkin from CMS described direct searches for such additional Higgs bosons decaying to SM particles or Higgs bosons. Loan Truong from ATLAS and Yuri Gershtein from CMS described studies of rare – and potentially beyond-SM – decays of the 125 GeV Higgs boson. No significant excesses were reported, but hope remains for Run 3, which will begin in 2021.

Nobel laureate Gerard 't Hooft gave a historical talk on the role of the Higgs in the renormalisation of electroweak theory, recalling the debt his Utrecht group, where the work was done almost 50 years ago, owed to pioneers like Faddeev and Popov. Seven years after the particle's discovery, we now know it to be spin-0 with mainly CP-even interactions with bosons, remarked Fabio Cerutti of Berkeley in the experimental summary. With precision on the Higgs mass now better than two parts per mille, all of the SM's free parameters are known with

**Looking up**  
Some Higgs measurements are on the verge of being systematics dominated.

high precision, he continued, and all but three of them are linked to Higgs-boson interactions.

Hunting season may now be over, Cerutti concluded, but the time to study the anatomy of the Higgs and exploit the 95% of LHC data still to come is close at hand. Giulia Zanderighi's theory summary had a similar message: Higgs studies are still in their infancy and the discovery of what seems to be a very SM-like Higgs at 125 GeV allows us to explore a new sector with a broad experimental programme that will extend over decades. She concluded with a quote from Abraham Lincoln: "Give me six hours to chop down a tree and I will spend the first four sharpening the axe."

The next Higgs Hunting workshop will be held in Orsay and/or Paris from 7-9 September 2020.

Louis Fayard Laboratoire de l'Accélérateur Linéaire.

CERN COURIER SEPTEMBER/OCTOBER 2019

## POWER FOR MODERN DETECTORS

MODULAR LOW AND HIGH VOLTAGE MULTICHANNEL POWER SUPPLY SYSTEMS



- ▶ highest channel density to save valuable installation space
- ▶ best ripple and noise characteristics
- ▶ up to 30 kV, up to 100 W per channel
- ▶ pure LV compatible, pure HV compatible and mixed setup crates available
- ▶ high class & quality precision low and high voltage supplies
- ▶ interchangeable controller boards for networking and software control



**NEW EHS FLEX HV Boards**  
High Voltage Supply highly customizable through plug-gable channels (by factory)



**High Class Low Voltage Boards**  
up to 16 channel LV for on site frontend hardware supply saves cable and installation space



**Controller Boards with Linux inside**  
integrated EPICS IOC, SNMP, OPC-UA and Webservices, also „bare metal“ use



OPC-UA, SNMP

WWW.WIENER-D.COM | WWW.ISEG-HV.COM/MMS



## FIELD NOTES

## FIELD NOTES

## PLANCK 2019

## Between desert and swampland

At the 22nd edition of the Planck conference series, which took place in Granada, Spain, from 3–7 June, 170 particle physicists and cosmologists discussed the latest in beyond the Standard Model (BSM) physics and ultraviolet completions of the SM within theories that unify the fundamental interactions.

Several speakers addressed the serious model-building restrictions in supersymmetry and Higgs compositeness that are imposed by the negative results of direct searches for BSM particles at ATLAS and CMS. Particular emphasis was put on the (extended) Higgs sector of the SM, where precision measurements might detect signals of BSM physics. Updates from LHCb and Belle on the flavour anomalies were also eagerly discussed, with proposed explanations including leptiquarks and additional U(1) gauge symmetries with exotic vector-like quarks. However, not all were convinced that the results signal

**Modular invariance**

Ferruccio Feruglio of INFN Padova ponders predictivity in the neutrino sector.

BSM physics. On the cosmological side, delegates learned of the latest attempts to build models of WIMPs, axions, magnetic relics and dark radiation, which also include mechanisms for baryogenesis and inflation in the early universe.

Given the absence of new BSM particles so far at the LHC, theorists talk of a “desert” beyond the weak and Planck scales containing nothing but SM particles. Several speakers reported that phase transitions between non-trivial

Higgs vacua could lead to violent phenomena in the early universe that might be tested by future gravitational-wave detectors. Within the inflationary universe these phenomena might also lead to the production of primordial black holes that could explain dark matter.

Discussions of ultraviolet (i.e. high-energy) completions of the SM encompassed the grand unification of fundamental interactions, the origin of neutrino masses, flavour symmetries and the so-called “swampland conjectures”, which characterise theories that might not be compatible with a consistent theory of quantum gravity. Therefore, one might hope that healthy signals of BSM physics might appear somewhere between the desert and the swampland.

Planck 2020 will be held from 8–12 June in Durham, UK.

Hans Peter Nilles University of Bonn.

## HUMBOLDT KOLLEG CONFERENCE

## Particle physics meets gravity in the Austrian Alps

The Humboldt Kolleg conference Discoveries and Open Puzzles in Particle Physics and Gravitation took place at Kitzbühel in the Austrian Alps from 24 to 28 June, bringing Humboldt prize winners, professors and research-fellow alumni together with prospective future fellows. The meeting was sponsored by the Humboldt Foundation, based in Bonn, whose mission is to promote cooperation between scientists in Germany and elsewhere. The programme focused on connections between particle physics and the large-scale cosmological structure of the universe.

The most recent LHC experimental results were presented by Karl Jakobs (Freiburg and ATLAS spokesperson), confirming the status of the Standard Model (SM). A key discussion topic raised by Fred Jegerlehner (DESY-Zeuthen) is whether the SM’s symmetries might be “emergent” at the relatively low energies of current experiments: in contrast to unification models that exhibit maximal symmetry at the highest energies, the gauge symmetries could emerge in the infrared, but “dissolve” in the extreme ultraviolet. Consider the anal-



ogy of a carpet: it looks flat and invariant under translations when viewed from a distance, but this smoothness dissolves when we look at it close up, e.g. as perceived by an ant crawling on it. A critical system close to the Planck scale – the scale where quantum-gravity effects should be important – could behave similarly: the only modes that can exist as long-range correlations, e.g. light-mass particles, self-organise into multiplets with a small number of particles, just as they do in the SM. The vector modes become the gauge bosons of U(1), SU(2) and SU(3); low-energy symmetries such as baryon- and lepton-number conservation would all be violated close to the Planck scale.

Ideas connecting particle physics and quantum computing were also discussed by Peter Zoller (Innsbruck) and Erez Zohar (MPQ, Munich). Here, one takes a

**Lofty thinking**

Humboldt Kolleg participants at the Hotel Kaiserhof in Kitzbühel.

lattice field theory that is theoretically difficult to solve and maps it onto a fully controllable quantum system such as an optical lattice that can be programmed in experiments to do calculations – a quantum simulator. First promising results with up to 20 qubits have been obtained for the Schwinger model (QED in 1+1 dimensions). This model exhibits dynamical mass generation and is a first prototype before looking at more complicated theories like QCD.

A key puzzle concerns the hierarchies of scales: the small ratio of the Higgs-boson mass to the Planck scale plus the very small cosmological constant that drives the accelerating expansion of the universe. Might these be related? The cosmological constant is related to the vacuum energy density, which is in turn connected to possible phase transitions in the early universe. Future gravitational-wave experiments with LISA were discussed by Stefano Vitale (Trento) and are expected to be sensitive to the effects of these phase transitions.

A main purpose of Humboldt Kolleg is the promotion of young scientists from the central European region. Student poster prizes sponsored by the Kitzbühel mayor Klaus Winkler were awarded to Janina Krzysiak (IF PAN, Krakow) and Jui-Lin Kuo (HEPHY, Vienna).

Steven Bass Kitzbühel Centre for Physics, Austria.

## WORKSHOP ON ATOMIC EXPERIMENTS FOR DARK MATTER AND GRAVITY EXPLORATION

## Interdisciplinary physics at the AEDGE

Following the discovery of gravitational waves by the LIGO and Virgo collaborations, there is great interest in observing other parts of the gravitational-wave spectrum and seeing what they can tell us about astrophysics, particle physics and cosmology. The European Space Agency (ESA) has approved the LISA space experiment that is designed to observe gravitational waves in a lower frequency band than LIGO and Virgo, while the KAGRA experiment in Japan, the INDIGO experiment in India and the proposed Einstein Telescope (ET) will reinforce LIGO and Virgo. However, there is a gap in observational capability in the intermediate-frequency band where there may be signals from the mergers of massive black holes weighing between 100 and 100,000 solar masses, and from a first-order phase transition or cosmic strings in the early universe.

This was the motivation for a workshop held at CERN on 22 and 23 July that brought experts from the cold-atom community together with particle physicists and representatives of the gravitational-wave community. Experiments using cold atoms as clocks and in

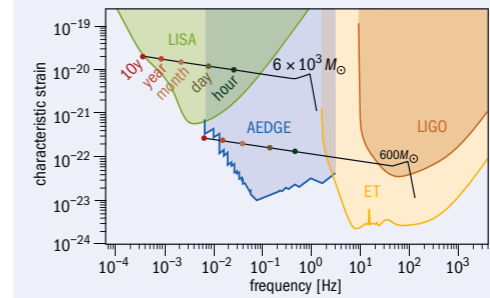

interferometers offer interesting prospects for detecting some candidates for ultra-light dark matter as well as gravitational waves in the mid-frequency gap. In particular, a possible space experiment called AEDGE could complement the observations by LIGO, Virgo, LISA and other approved experiments.

The workshop shared information about long-baseline terrestrial cold-atom experiments that are already funded and under construction, such as MAGIS in the US, MIGA in France and ZAIGA in China, as well as ideas for future terrestrial experiments such as

**Frequency niche**

AEDGE could observe the infalls and mergers of binary massive black holes. The toy models correspond to a redshift  $z=2$ .

MAGIA–advanced in Italy, AION in the UK and ELGAR in France. Delegates also heard about space – CACES (China) and CAL (NASA) – and sounding-rocket experiments – MAIUS (Germany) – using cold atoms in space and microgravity.

ESA has recently issued a call for white papers for its Voyage 2050 long-term science programme, and a suggestion for an atom interferometer using a pair of satellites is being put forward by the AEDGE team (in parallel with a related suggestion called STE-QUEST) to build upon the experience with prior experiments. AEDGE was the focus of the CERN workshop, and would have unique capabilities to probe the assembly of the super-massive black holes known to power active galactic nuclei, physics beyond the Standard Model in the early universe and ultra-light dark matter. AEDGE would be a uniquely interdisciplinary space mission, harnessing cold-atom technologies to address key issues in fundamental physics, astrophysics and cosmology.

Oliver Buchmueller Imperial College London, Albert De Roeck CERN and John Ellis King’s College London.

## FCC WEEK 2019

## Study comes full EuroCirCol

More than 400 researchers convened in Brussels from 24 to 28 June for the annual meeting of the Future Circular Collider (FCC) study. In addition to innovations in superconductivity, high-field magnets, superconducting radio-frequency systems and civil-engineering studies, discussions sought to clarify issues surrounding the physics research topics that FCC can address.

The meeting also marked the final event of the Horizon 2020 EuroCirCol project – a European Union project to produce a conceptual design study for a post-LHC research infrastructure based on an energy-frontier 100 TeV circular hadron collider. Since June 2015 the project has produced a wealth of results in high-tech domains via the collaborative efforts of partners in Europe and other countries such as the US, Japan, Korea and Russia. These include impressive progress toward 16 T magnets and in the performance of superconducting wires. Breakthroughs in both fields, such as a first accelerator-type magnet exceeding 14 T (see p7)

**Brussels clout**

CERN Director-General Fabiola Gianotti at FCC Week 2019.

and an increase in the critical current density of Nb<sub>3</sub>Sn wire, promise to significantly reduce the costs of exploring the high-energy frontier and could find practical applications outside particle physics.

The four-volume FCC conceptual design report was also presented. Authored by 1350 people from 150 institutes, the report “underlines the global attractiveness of the FCC and documents the far-reaching benefits that the project can have for Europe and future generations,” said Frédéric Bordry, CERN director for accelerators and technologies.

A wide range of talks focused on a future circular lepton collider (FCC-ee) as the first step of the FCC programme, followed by an energy-frontier proton collider (FCC-hh). Results testify to the

technological readiness of the FCC-ee, which could be operational by the end of the 2030s and therefore allow time to develop the novel technologies required for a 100 TeV proton–proton collider.

In his keynote talk, Nima Arkani-Hamed of the Institute for Advanced Study highlighted the importance of scrutinising the Higgs boson at a post-LHC machine. Speakers also stressed the complementarity between the different FCC options in searching for dark-matter candidate particles and other new physics. Finally, the potential for studying the strong interaction with heavy-ion collisions, and detailing parton distribution functions with a proton–electron interaction point, were demonstrated.

The sustainability of research infrastructures and the assessment of their societal impact were other highlights of FCC week 2019, as discussed at a special “Economics of Science” workshop. Experts from the field of economics shared lessons learned with representatives from CERN and other research organisations, including SKA, ESA and ESS, demonstrating the many benefits beyond physics that major international projects bring.

Panos Charitos CERN.

### Ultra High Performance Silicon Drift Detector

#### FAST SDD®

Count Rate => 1,000,000 CPS

#### The True State-of-the-Art

- New in-house manufacturing
- Lower noise
- Lower leakage current
- Better charge collection

Compatible with EPICS tools & libraries

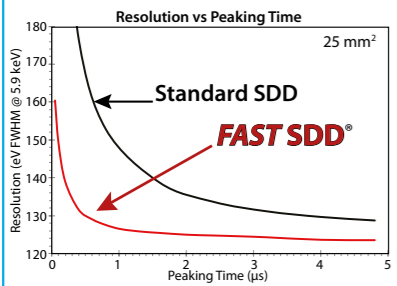
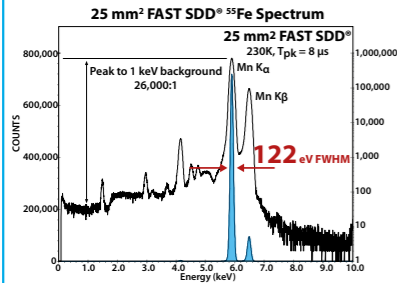

#### Options:

- 25 mm² active area collimated to 17 mm²
- 70 mm² collimated to 50 mm²
- Windows: Be (0.5 mil) 12.5 μm, or C Series (Si3N4)
- TO-8 package fits all Amptek configurations
- Vacuum applications



40 Years of Products for Your Imagination



### FIELD NOTES

#### STRANGENESS IN QUARK MATTER

## Quark-matter mysteries on the run in Bari



Golden age SQM 2019 highlighted the fast pace of developments in heavy-ion research.

The XVIII International Conference on Strangeness in Quark Matter (SQM 2019) was held from 10 to 15 June in Bari, Italy. With 270 delegates from 32 countries, the largest participation ever for the SQM series, the conference focused on the role of strange and heavy-flavour quarks in heavy-ion collisions and astrophysics. The scientific programme consisted of 50 invited plenary talks, 76 contributed parallel talks and a rich poster session with more than 60 contributions.

A state-of-the-art session opened the conference, also including a tribute to the late Roy Glauber entitled "The Glauber model in high-energy nucleus-nucleus collisions". Subsequent sessions were dedicated to highlights from theory and experiment, and included reports on results from low- and high-energy collisions, as well as on hyperon interactions in lattice QCD and thermal models. Representatives from all major collaborations at CERN's LHC and SPS, Brookhaven's RHIC, the Heavy Ion Synchrotron SIS at the GSI Darmstadt and the NICA project at the JINR Dubna made special efforts to release new results at SQM 2019.

Among the highlights were reports that particle-yield measurements are close to determining where phenomena such as strangeness enhancement are localised in phase space. Collective behaviour in small systems was also a much-discussed topic, with new results from the PHENIX experiment showing that p-Au, d-Au and <sup>3</sup>He-Au collisions exhibit elliptic flow coefficients consistent with expectations regarding their initial collision geometry. Results from ALICE, CMS and STAR consistently corroborate the presence of elliptic flow in small systems.

There is also increasing interest in transverse-momentum differential baryon-to-meson ratios in the heavy-flavour sector. Recent results from pp and Pb-Pb collisions from both ALICE and CMS suggest that the same dynamics observed in the ratio  $\Lambda/K_S^0$  may be present in  $\Lambda_c/D$ , despite the fact that strange and charm quarks are thought to be

created in different stages of the system's evolution. Further studies and future measurements may be needed.

A promising new perspective for the LHC data is to use high-energy pp and p-Pb collisions as factories of identified hadrons created by a source of finite radius and then to measure the ensuing interactions between these hadrons using femtoscopy. This technique has allowed the ALICE collaboration to study interactions that were so far not measured at all and probe, for instance, the p-Ξ and p-Ω interaction potentials. These results provide fundamental constraints to the QCD community and are significant in the context of the astrophysics.

New results on the onset of deconfinement were shown by the NA61/SHINE collaboration. First results on strangeness production at low energy from HADES and BM@N also enriched the discussion at SQM 2019.

Presentations at the final session showed good prospects for future measurements at FAIR (GSI Darmstadt), NICA (JINR Dubna), the Heavy-Ion Project (J-PARC), and at CERN, given ongoing detector upgrades, the high-luminosity programme, and possible next-generation colliders. Perspectives for QCD measurements at future electron-ion colliders were also presented. On the theory side, new developments and strong research efforts are bringing a better understanding of strangeness production and open heavy-flavour dynamics in heavy-ion collisions.

Young scientist prizes sponsored by the Nuclear Physics European Collaboration Committee were awarded to Bong-Hwi Lim of Pusan National University, Korea, and to Olga Soloveva of Goethe University, Frankfurt for their poster contributions. The inaugural Andre Mischke Award (established at SQM2019) for the young scientist with the best experimental parallel talk was given to Erin Frances Gauger of the University of Texas, Austin.

The next edition of SQM will take place in Busan, Korea, in May 2021.

Domenico Elia INFN Bari.

#### g-2 PHYSICS WEEK

## Muon g-2 collaboration prepares for first results

The annual "g-2 physics week", which took place on Elba Island in Italy from 27 May to 1 June, saw almost 100 physicists discuss the latest progress at the muon g-2 experiment at Fermilab. The muon magnetic anomaly,  $a_\mu$ , is one of the few cases where there is a hint of a discrepancy between a Standard Model (SM) prediction and an experimental measurement. Almost 20 years ago, in a sequence of increasingly precise measurements, the E821 collaboration at Brookhaven National Laboratory (BNL) determined  $a_\mu = (g-2)/2$  with a relative precision of 0.54 parts per million (ppm), providing a rigorous test of the SM. Impressive as it was, the result was limited by statistical uncertainties.

in both frequencies. The absolute values of the two frequencies are still subject to a ~25 ppm hardware blinding offset, so no physics conclusion can yet be drawn. But the exercise has shown that the collaboration is well on the way

to publishing its first result with a precision better than E821 towards the end of the year.

Marco Incagli and Graziano Venanzoni INFN Sezione di Pisa.

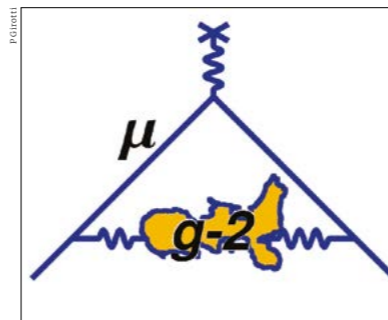

Fuzzy physics The "Elba vacuum polarisation" represents the missing piece in the muon's anomalous magnetic moment.

A new muon g-2 experiment currently taking data at Fermilab, called E989, aims to improve the experimental error on  $a_\mu$  by a factor of four. The collaboration took its first dataset in 2018, integrating 40% more statistics than the BNL experiment, and is now coming to the end of a second run that will yield a combined dataset more than three times larger.

A thorough review of the many analysis efforts during the first data run has been conducted. The muon magnetic anomaly is determined from the ratio of the muon and proton precession frequencies in the same magnetic field. The ultimate aim of experiment E989 is to measure both of these frequencies with a precision of 0.1 ppm by employing techniques and expertise from particle-physics experimentation (straw tracking detectors and calorimetry), nuclear physics (nuclear magnetic resonance) and accelerator science. These frequencies are independently measured by several analysis groups with different methodologies and different susceptibilities to systematic effects.

A recent relative unblinding of a subset of the data with a statistical precision of 1.3 ppm showed excellent agreement across the analyses

**M2p series**

Generate up to 8 signals

M2p.65xx 8 variations

DN2.65x 6 variations

Ethernet

5 YEARS WARRANTY

Generate up to 16 signals

- 16 bit AWGs with 40 or 125 MS/s
- Precise test signals from DC to 60 MHz
- 700 MByte/s FIFO streaming (PCIe)

**SPECTRUM**  
INSTRUMENTATION

Perfect fit – modular designed solutions

Europe / Asia: Phone +49 (4102) 695 60 | US: Phone (201) 562 1999

[www.spectrum-instrumentation.com](http://www.spectrum-instrumentation.com)





**Breakthrough**  
New service tunnels for the high-luminosity LHC being excavated at Point 5 in July.

# TUNNELLING FOR PHYSICS

Surveying the geological, environmental and technical constraints of a post-LHC collider.

In 2012 the CERN management asked a question: what is the largest circular machine that could be feasibly constructed in the Geneva region from a civil-engineering perspective? Teams quickly embarked on an extensive investigation of the geological, environmental and technical constraints in pursuit of the world's largest accelerator. Such a machine would be the next logical step in exploring the universe at ever smaller scales.

Since construction of the 27 km circumference Large Hadron Collider (LHC) was completed in 2005, CERN has been looking at the potential layouts for the tunnels that will house the next generation of particle accelerators. The Compact Linear Collider (CLIC) and the Future Circular Collider (FCC) are the two largest projects under consideration. With a circumference of 100 km, the FCC will require one of the world's largest tunnels – almost twice as long as the recently completed 57 km Gotthard Base Tunnel in

**THE AUTHORS**  
**John Osborne,**  
**Alexandra Tudora**  
**and Ben Swatton**  
CERN.

the Swiss Alps. Designing large infrastructure like the FCC tunnel requires the collection and interpretation of numerous data, which have to be balanced for the optimum level of risk, cost and project requirements.

The first and most important task in designing tunnels is to understand the needs and requirements of the users. For road or rail tunnels, this is relatively straightforward. For a cutting-edge scientific experiment, multi-disciplinary working groups are needed to identify the key criteria. The diameter of a new tunnel depends on what components would be inside – ventilation systems, magnets, lighting, transport corridors, etc – so they can fit in like a jigsaw.

**Bespoke designs**

Unlike other tunnelling projects, there are no standard rules or guidance for the design of particle-accelerator tunnels, meaning each design is, to a large extent, bespoke. One

**Fig. 1.** The scale of the proposed CLIC and FCC projects would dwarf CERN's existing infrastructure, making them some of the largest tunnelling projects in the world.

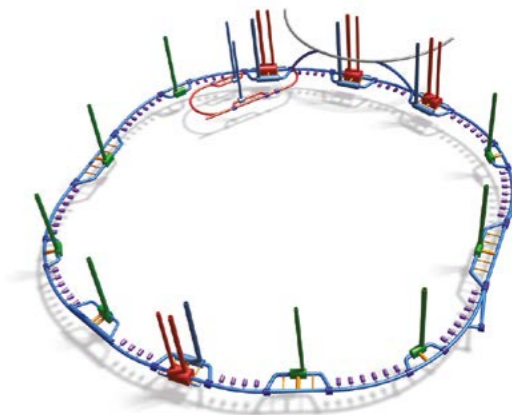
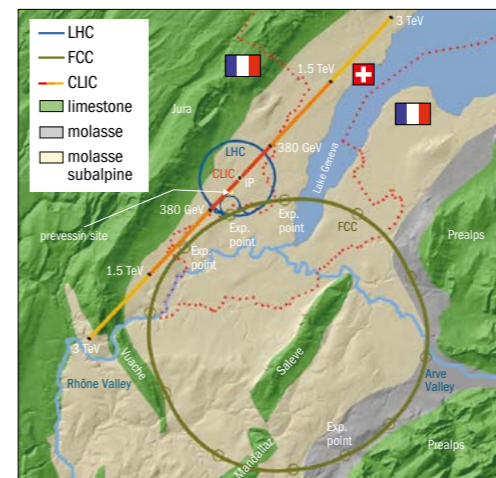

**Fig. 2.** The FCC would be made of a series of straight sections and curves, with numerous shafts, caverns and adits.

reason for this is the sensitivity of the equipment inside. Digging a 5.6 m-diameter hole disturbs rock that has been there for millennia, causing it to relax and to move. Modern tunnelling techniques can control these movements and get a tunnel to within a few centimetres of its intended design. For example, the two ends of the 27 km LEP ring came together with just 1 cm of error. It would be impossible to achieve the nanometre-level tolerances that the beamline requires, so the sensitive equipment installed in a completed accelerator tunnel must incorporate adjustable alignment systems into their designs.

The city of Geneva sits on a large plateau between the Jura and Prealps mountains. The bedrock of the plateau is a competent (resistant to deformation) sedimentary rock, called molasse, which formed when eroded material was deposited and consolidated in a basin as the Alps lifted up.

On top of the molasse sits a softer soil, called the moraines, which is made up of more recent, unconsolidated glacial deposits. The Jura itself is made of limestone rock, which while competent, is soluble and can form a network of underground voids, known as karsts.

We can never fully understand the ground before we start tunnelling and there is always the risk of encountering something unexpected, such as water, faults or obstructions. These cost money to overcome and/or delay the project; in the worst cases, they may even cause the tunnel to collapse. To help mitigate these risks and provide technical information for the tunnel design, we investigate the ground in the early stages of the project by drilling boreholes and testing ground samples. Like most things in civil engineering, however, there is a balance between the cost of the investigations versus the risks they mitigate.

**CERN's tunnel optimisation tool**

In 2014, with the help of UK-based engineering consultancy Arup, CERN developed the tunnel optimisation tool (TOT) to integrate project requirements and data into a geospatial model. The web-based tool allows the user to digitally move the FCC tunnel, change its size, shape and depth and see, in real-time, the impacts of the changes on the design. Geology, surface constraints and environmentally protected areas are visualised, and parameters such as plane inclinations and tunnel depth can be changed at the click of a mouse. The tool warns users if certain limits are exceeded or obstacles are encountered, for example, if a shaft is in the middle of Lake Geneva! When it was built, TOT was the first of its kind within the industry. It has cut the cost of the civil-engineering design and has provided us with the flexibility to meet

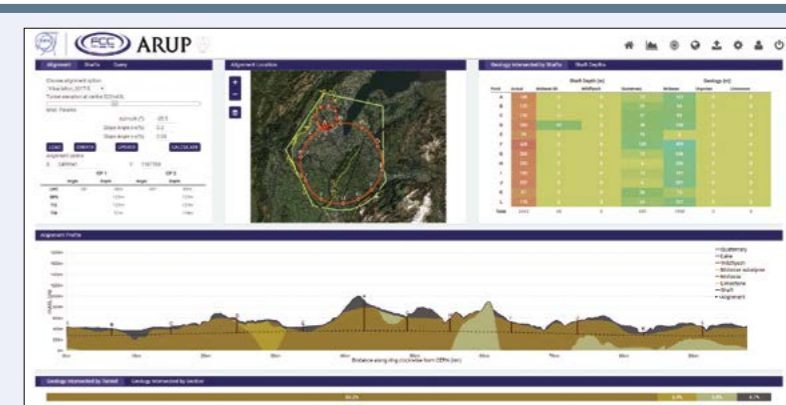

changing requirements to ultimately deliver a better project. The success of TOT led to its replication for CLIC and the International Linear Collider (ILC) under consideration

in Japan. Recently, a TOT was built by Arup to quickly and cheaply assess a range of alignments for a 3 km tunnel under the ancient Stonehenge heritage site in the UK.



## Exciting Innovations for Research Scientists The VORTEX® ME-7 SDD

7 x 50 mm<sup>2</sup> SDD sensors in a probe diameter of 38.1 mm

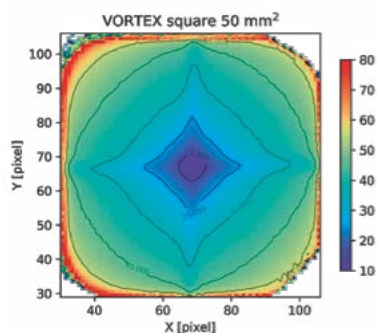

VORTEX ME-7 SDD Rise Time Mapping

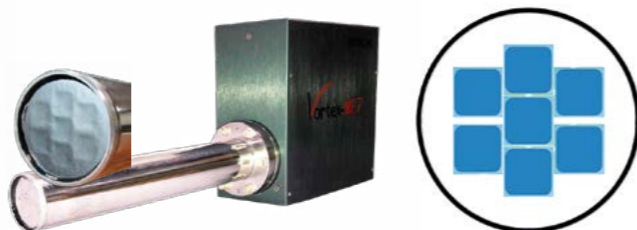

VORTEX ME-7 SDD— 38 mm diameter  
Detector - the same as the current  
VORTEX ME-4 SDD

AND

## The VORTEX® 2mm thick SDD Sensor

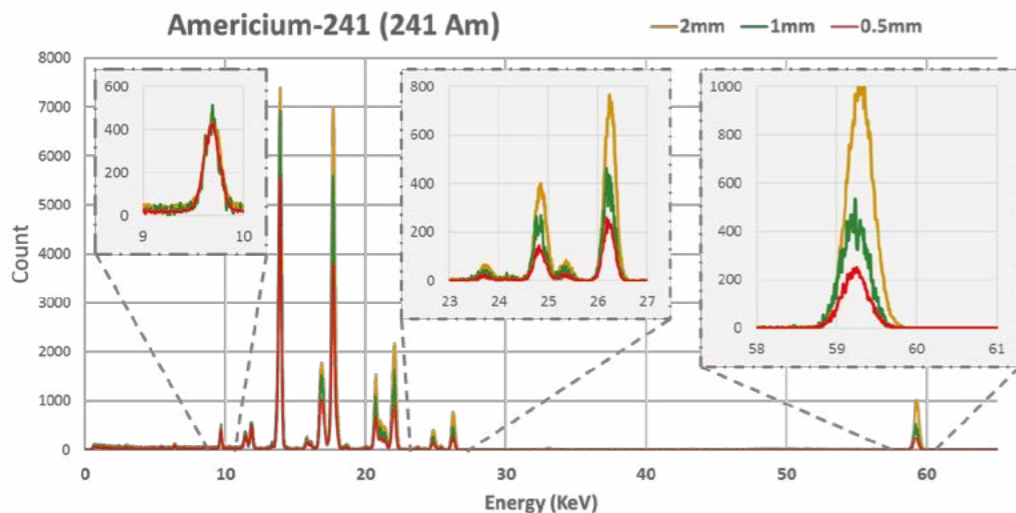

Contact us to discuss the future

Hitachi High-Technologies Science America, Inc.  
21770 Nordhoff St., Chatsworth, CA 91311

www.hitachi-hightech.com/hhs-us/  
Email: sales@hitachi-hitec-science.us  
Tel: +1-818-280-0745

No boreholes have been sunk specifically for FCC yet, but we have access to a substantial amount of data from the LHC and from the Swiss and French authorities.

The answer to CERN's question in 2012 was that a (quasi-) circular tunnel up to 100 km long could be built near Geneva (figure 1). This will be confirmed with further site investigations to verify the design assumptions and optimise a layout for the new machine. The FCC study considers two potential high-energy accelerators: hadron-hadron and electron-positron, and the FCC would consist of a series of arcs and straight sections (figure 2). Depending on the choice of a future collider, civil-engineering designs for FCC and/or CLIC will need to be developed further. Although the challenges between the two studies differ, the processes and tools used will be similar.

### Optimising the alignment

Having determined the FCC's feasibility, CERN's civil engineers started designing the optimal route of the tunnel. Geology and topography are the key constraints on the tunnel position. Two alignment options were under consideration in 2012, both 80 km long, one located under the Jura Mountains and the other in the Geneva basin. When the FCC study officially kicked off in 2014, they were reviewed alongside a 47 km-circumference option fully excavated in the molasse.

Experience of tunnelling through Jura limestone during construction of the Large Electron Positron collider (LEP; from which the LHC inherited many of its tunnels) convinced

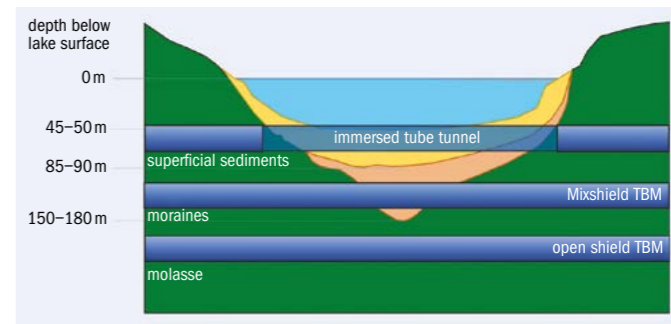

Fig. 3. Modern technology presents different options for tunnelling under Lake Geneva, which is one of the main constraints on the alignment of the FCC.

civil engineers to discard the Jura option. Mining through the karstic limestone caused several delays and costly repairs after water and sediment flowed into the tunnel (see p39). To this day, intensive maintenance works are needed between sectors 3 and 4 of the LHC tunnel and this has led to machine shutdowns lasting as long as two weeks. By 2016, the proposed length of the FCC had increased to between 80 and 100 km to achieve higher energies with two alignments under consideration: intersecting (which crosses the LHC in plan view) and non-intersecting. The former is the current baseline design. The tunnel is located primarily in the competent molasse rock and avoids the problematic Jura limestone and the Prealps. However, it does pass through the Mandallaz limestone formation and also

### Advances in civil engineering since the LEP days

It has been almost 35 years since three tunnel boring machines (TBMs) set off to carve out the 27 km-long hole that would house LEP and, later, the LHC. Contrary to the recent claims of tech entrepreneur Elon Musk, the technology used to construct modern tunnels has been quietly and rapidly advancing since the construction of LEP, providing a faster, safer and more versatile way to build tunnels. TBMs act as a mobile factory that simultaneously excavates rock from the face and builds a tunnel lining from prefabricated segments behind it. The outer shield of the machine protects workers from falling rock, making sure they are never working in unsupported ground.

One of the main advances in TBM technology is their ability to cope in variable ground conditions. Most of the LEP tunnels were constructed in dry, competent rock, meaning the excavation face needed little support to stand up. Underneath the Jura Mountains, however, pockets of water and soil form where the limestone dissolves into karsts. When a TBM hits this, the water can flow into the tunnels, causing flooding and, at worst, tunnel collapse. Modern TBMs come with a variety of face-support measures, including



earth-pressure balance machines that use the excavated soil to push back against the excavated face for support. Herrenknecht's Mixshield TBM (above) could be used to tunnel the FCC under Lake Geneva, where water-bearing moraines are encountered.

Segmental linings can be constructed off-site in a factory, improving quality, speed and safety. The segments are assembled in the rear of the TBM immediately after excavation. The segments can be fitted with a rubber gasket, which provides a waterproof seal, eliminating the need for the traditional secondary lining. Across the 100 km of the FCC, this will lead to substantial cost savings.

Seismic and sonic scanners can be mounted to the front of the TBM, allowing operators to detect voids or obstacles up

to 40 m ahead and adjust their approach accordingly. Probe drilling and pre-support measures can also be implemented from within the machine, meaning that the mining crew is safe and minimising delays to the construction programme.

For vertical shafts, the vertical shaft sinking machine and shaft boring machine are the latest technological breakthroughs, taking all the technology of a TBM and standing it on its end. The giant rig hangs off a crane and excavates below the platform, whilst building a lining above it. The machine can even work underwater to stabilise the shafts during construction.

Traditional tunnelling techniques, which are useful for creating non-standard shapes or smaller tunnels like the experimental caverns in FCC, have come a long way, too. These aren't the normal sticks of dynamite you see in films or cartoons - highly stable explosives are slotted precisely in holes using a giant rig with multiple arms for speed. The electric detonators can be configured to the millisecond for complex patterns of explosions that give tunnellers precise control of the shape, speed and quality of the excavation.

FEATURE TUNNEL ENGINEERING

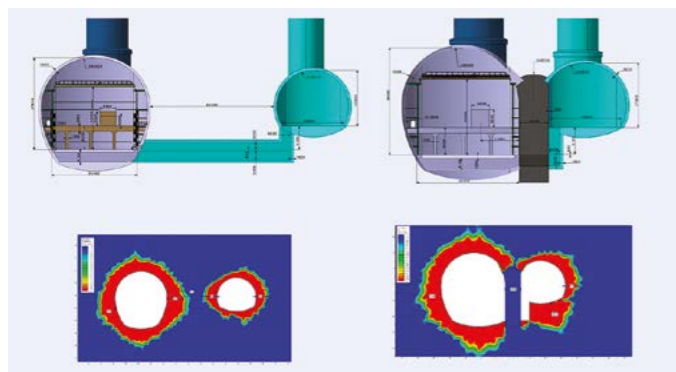

**Fig. 4.** Stress analysis of separated (left) versus adjacent service and experimental caverns.

has to cross under Lake Geneva. To deal with the wealth of topographical, geological and environmental data relevant for a 100 km ring, CERN embarked on an innovative tunnel optimisation tool (TOT) that would let us assess a multitude of alignment options in a fraction of the time (see “CERN’s tunnel optimisation tool”).

The alignment of the FCC tunnel has been optimised based on three key criteria at this stage: geology (building in the competent molasse rock wherever possible); shaft depth (minimising the depth of shafts); and surface sites (choosing locations that minimise disruption to residents and the environment).

Despite the best efforts to avoid the risky Jura Mountains, the geology is not perfect. The Prealps region has complex, faulted geology and it is uncertain which layers the tunnel will cross. Cracks or faults, caused by tectonic movements of the Alps and Jura, can occur in the molasse and limestone. Excavation through Mandallaz limestone can lead to similar issues encountered during LEP’s construction. Large, high-pressure inflows can be difficult to remedy, expensive and can create delays in the programme.

To minimise the depth of the shafts, the entire FCC ring sits in an inclined plane with different heights above sea level around the tunnel. Modelling a range of alignment options at different locations and with different tunnel inclinations, constrained by the spacing requirements of the experiments, it turned out that one shaft was 558 m deep in the baseline design. The team therefore decided to replace the vertical shaft with an inclined tunnel (15% slope) to pop out the side of the mountain.

The presence of Lake Geneva influences the overall depth of the FCC, and the tunnel optimisation tool tells us that it isn’t possible to avoid tunnelling under the lake within the study boundary. Modern tunnelling techniques open up different options for crossing the lake, instead of simply digging deeper until we reach the rock (figure 3). Several options were considered, even including an option to build a hybrid particle accelerator-road tunnel in an immersed tube tunnel (which was later scrapped because of potential vibrations caused by traffic disrupting the beamline). The current design compromises on a mid-depth tunnel passing through the permeable moraines on the lake bed.

At the bottom of some of the FCC shafts are large experimental caverns with spans of up to 35 m. To determine the

best arrangement for experimental and service caverns, Amberg Engineering carried out a stress analysis (figure 4). Although for data-acquisition purposes it is often desirable to have the two caverns as close as possible to each other, the analysis showed that it would be prohibitively expensive to build a 10 m concrete wall between the caverns. The cheaper option is to use the existing rock as a natural pillar, which would require a minimum spacing of 45 m.

Tunnelling inevitably disturbs the surrounding area. The beamline of the LHC is incredibly sensitive and can detect even the smallest vibrations from the outside world. This was a potential issue for construction works currently taking place for the High-Luminosity LHC project. The contractor had to improvise and modify a standard diesel excavator with an electric motor to eliminate vibrations from the engine. The programme was also adapted so that only the shafts were constructed during operation of the LHC, leaving the more disruptive cavern construction until the start of the current shutdown.

**Securing the future**

CERN currently has 83 km of underground structures. The FCC would add over 100 km of tunnels, 3720 m of shafts, 26 caverns (not including junction caverns), 66 alcoves and with up to 30 km between the Meyrin campus and the furthest site. The estimated civil-engineering cost for FCC (carried out by ILF Consulting Engineers) is approximately 6 billion Swiss Francs – 45% for tunnels and the rest for shafts, caverns and surface facilities – and benefits from significant advances in tunnelling technology since the LEP-tunnel days (see “Advances in civil engineering since the LEP days”).

The safety of the underground areas is critical to ensure the safe and continued operation of the experiments, and CERN has developed advanced tools to inspect the structures – some of which are more than 60 years old. Manually inspecting the condition of the structures on the scale of the FCC will become extremely challenging. We are therefore developing new technologies that will allow us to monitor the condition of the tunnels remotely. Currently, teams are testing out how fibre-optic cables can be attached to the concrete linings to measure movements over time, and developing and training algorithms to be able to spot and characterise faults in the tunnel lining. In the future, the software will be able to measure these faults and compare the changes with previous inspections to assess how they have progressed. To capture these images, a Tunnel Inspection Machine, which runs on the monorail in the roof of the LHC, and a floor-roving inspection robot have both been tested to collect images and data, even when the tunnel is not safe for humans. These images can be rebuilt in a 3D environment and viewed through a virtual-reality headset.

Projects like the FCC and CLIC are not just exciting for physicists. For civil engineers they represent challenges that demand new ideas and technology. At the annual World Tunnel Congress, attended by more than 2000 leading tunnel and underground-space experts, CERN’s FCC has already generated great interest. If approved, it would require the largest construction projects science has ever seen, bequeathing a tunnel that would serve fundamental exploration into the next century. ●

**The presence of Lake Geneva influences the overall depth of the FCC**

## 300kW All Solid-State RF Amplifier

### Model : CA500BW2-8085RP

R&K Company Limited R&K provides the world’s most reliable high performance solid-state RF Power Amplifiers.

**AMPLIFIER DESIGN**

- Consists of four (4) rack-mounted 75kW SSAs.
- Able to deliver 300kW via 4-way power combiner.
- 96-way radial combiner for final power combining of 75kW SSA.
- Long-term & highly reliable operation achieved by protecting each final-stage transistor with built-in circulator at its output.

**Output Power Linearity**

**Output Pulse**

**Pulse Rise**

**Pulse Fall**

**SPECIFICATION**

Frequency Range : 500MHz±1MHz  
 Output Power : 320kW @Peak, 300kW (min.)  
 \*Each rack-mounted amplifier section individually delivers 75kW. (75kW/rack ×4 outputs)  
 Pulse Width : 1µs~300µs (max.)  
 Duty : 0~3% (max.)  
 Operation Mode : Class AB  
 AC Supply Input : AC200V±10%/3φ, 50/60Hz  
 Size : (W)2240mm×(D)1300mm×(H)1510mm

**R&K Company Limited**  
[www.rk-microwave.com](http://www.rk-microwave.com)  
 721-1 Maeda, Fuji-City, Shizuoka, 416-8577 Japan  
 Tel:+81-545-31-2600 Fax:+81-545-31-1600 Email:info@rkco.jp

## Advancing Cryogenics

Lake Shore offers precision input modules for cryogenic monitoring in PLC-based applications

**240 Series Input Modules**  
 Remote temperature monitoring for large facilities

**Key features:**

- Cryogenic temperature sensor inputs (RTD & diode)
- Natively supports PROFIBUS
- On-board conversion to calibrated temperature units
- Temperature monitoring down to 1 K & up to 800 K
- Current reversal to minimize thermoelectric offsets
- Supports long cable connections to sensors
- Compact package for DIN rail installation

Optimized for use with Cernox® sensors

ADVANCING SCIENCE  
614.891.2243 | [www.lakeshore.com](http://www.lakeshore.com)

**Evaluation kits now available.**  
 Visit [www.lakeshore.com/240](http://www.lakeshore.com/240) for details.



# LEP'S ELECTROWEAK LEAP

In the autumn of 1989 the Large Electron Positron collider (LEP) delivered the first of several results that still dominate the landscape of particle physics today.

In the early 1970s the term “Standard Model” did not yet exist – physicists used “Weinberg–Salam model” instead. But the discovery of the weak neutral current in Gargamelle at CERN in 1973, followed by the prediction and observation of particles composed of charm quarks at Brookhaven and SLAC, quickly shifted the focus of particle physicists from the strong to the electroweak interactions – a sector in which trailblazing theoretical work had quietly taken place in the previous years. Plans for an electron–positron collider at CERN were soon born, with the machine first named LEP (Large Electron Positron collider) in a 1976 CERN yellow report authored by a distinguished study group featuring, among others, John Ellis, Burt Richter, Carlo Rubbia and Jack Steinberger.

LEP's size – four times larger than anything before it – was chosen from the need to observe W-pair production, and to check that its cross section did not diverge as a function of energy. The phenomenology of the Z-boson's decay was to come under similar scrutiny. At the time, the number of fermion families was undefined, and it was even possible that there were so many neutrino families that the Z line-shape would be washed out. LEP's other physics targets included the possibility of producing Higgs bosons. At the time, the mass of the Higgs boson was completely unknown and could have been anywhere from around zero to 1 TeV.

The CERN Council approved LEP in October 1981 for centre-of-mass energies up to 110 GeV. It was a remarkable vote of confidence in the Standard Model (SM), given that the W and Z bosons had not yet been directly observed. A frantic period followed, with the ALEPH, DELPHI, L3 and OPAL detectors approved in 1983. Based on similar geometric principles, they included drift chambers or TPCs for the main trackers, BGO crystals, lead–glass or lead–gas sandwich electromagnetic calorimeters, and, in most cases, an instrumented return yoke for hadron calorimetry and muon filtering. The underground caverns were finished in 1988 and the detectors were in various stages of installation by the end of spring 1989, by which time the storage ring had been installed in the 27 km–circumference tunnel (see p39).

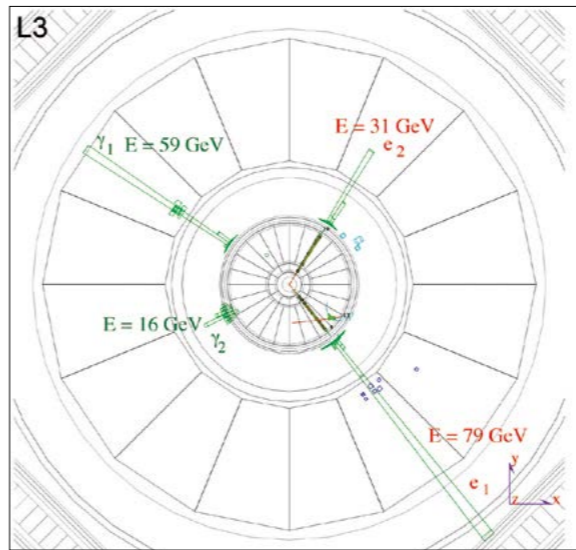
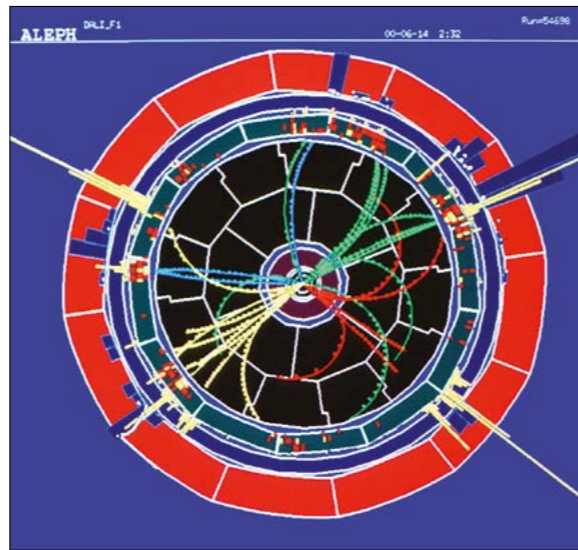
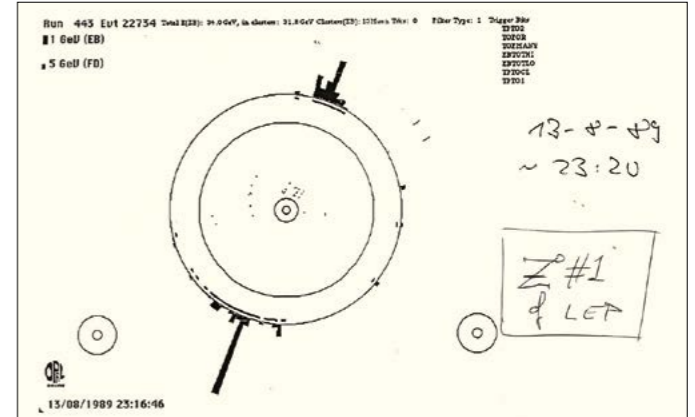
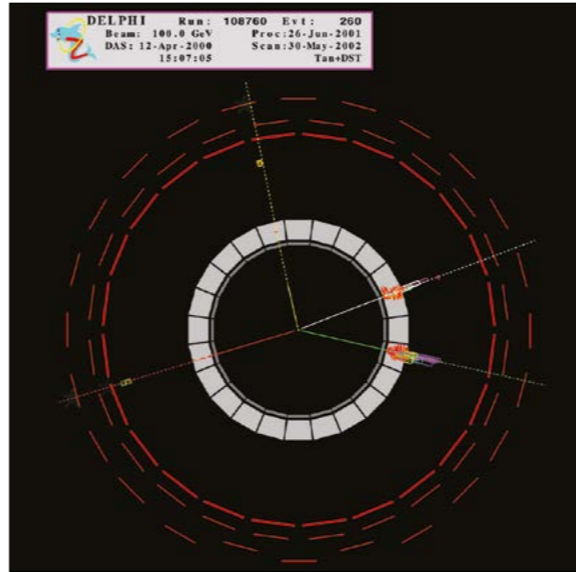
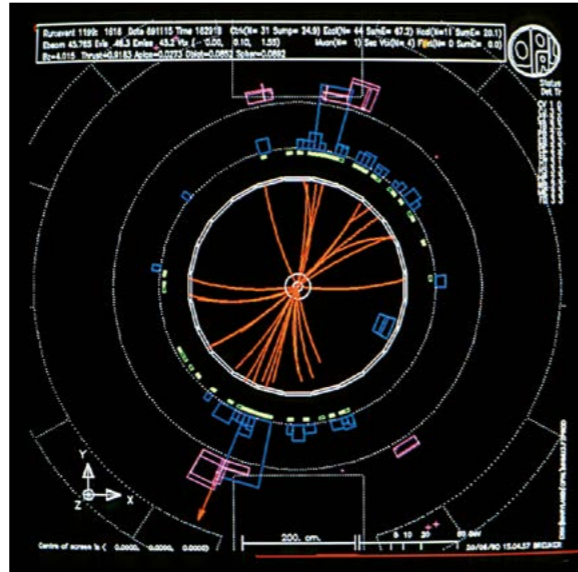

**Trailblazing events** Clockwise from top left: OPAL spots the decay of a Z boson into two jets originating from a quark–antiquark pair; a pair of Z bosons decaying into two muons and two electrons in DELPHI; an L3 candidate for pair production of excited electrons decaying into an electron and a photon each; and a four–jet event recorded in 2000 by ALEPH that was a candidate for the associated production and decay of a Z and a Higgs boson into quark–antiquark pairs.

neutrinos was well established. Several model–dependent measurements from astrophysics and collider physics at the time had pointed to the number of light active neutrinos ( $N_\nu$ ) being less than five, but the SM could, in principle, accommodate any higher number.

**OPAL fruits**  
The OPAL logbook entry for the first Z boson seen at LEP, recorded late on 13 August 1989.

The initial plan to measure  $N_\nu$  using the total width of the Z resonance was quickly discarded in favour of the visible peak cross section, where the effect was far more prominent – and in first approximation, insensitive to new possible detectable channels. The LEP experiments were therefore thrown in at the deep end, needing to make an absolute cross–section measurement with completely new detectors in an unfamiliar environment that demanded triggers, tracking, calorimetry and the luminosity monitors to all work and acquire data in synchronisation.

On the evening of 13 August, during a first low–luminosity pilot run just one month after LEP achieved first turns, OPAL reported the first observation of a Z decay (see image above). Each experiment quickly observed a handful more. The first Z–production run took place from 18 September to 9 October, with the four experiments accumulating about 3000 visible Z decays each. They took data at the Z peak and at 1 and 2 GeV either side, improving the precision on the Z mass and allowing a measurement of the peak cross section. The results, including those from the Mark II collaboration at SLAC's linear electron–positron SLC collider, were published and presented in CERN's overflowing main auditorium on 13 October.

After only three weeks of data taking and 10,000 Z decays, the number of neutrinos was found to be three. In the following years, some 17 million Z decays were accumulated, and cross–section measurement uncertainties fell

**THE AUTHORS**

**Alain Blondel** LPNHE Paris, CERN and University of Geneva, **Chiara Mariotti** INFN Torino, **Marco Pieri** CERN and UC San Diego, and **Pippa Wells** CERN.

**Expedition to the Z pole**

The first destination was the Z pole at an energy of around 90 GeV. Its location was then known to  $\pm 300$  MeV from measurements of proton–antiproton collisions at Fermilab's Tevatron. The priority was to establish the number of light neutrino families, a number that not only closely relates to the number of elementary fermions but also impacts the chemical composition and large–scale structure of the universe. By 1989 the existence of the  $\nu_e$ ,  $\nu_\mu$  and  $\nu_\tau$

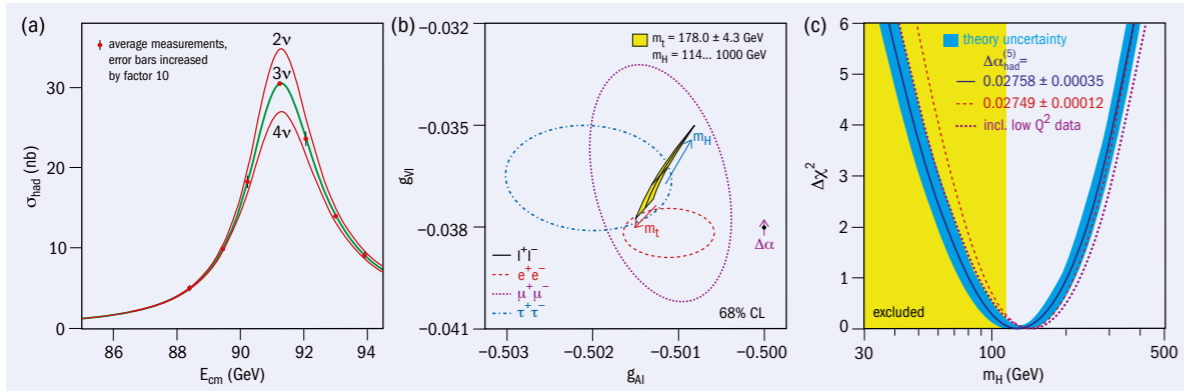

**Fig. 1.** (a) Z-pole cross-section measurement from the four LEP experiments after seven years of running, establishing that the number of light neutrino families is equal to three. (b) Precision measurements at LEP, showing measurements of neutral-current lepton couplings for electrons, muons and taus, and the average over the leptons, from the Z width, branching ratios and asymmetries (the purple arrow on the right represents the SM predictions without EW radiative corrections). (c) The data from the Z line shape and the direct searches predicted – assuming the Standard Model and nothing else – a Higgs boson mass between 115 GeV and 285 GeV at 95% confidence. The yellow region shows the direct exclusion from LEP.

to the per-mille level. And while the final LEP number –  $N_\nu = 2.9840 \pm 0.0082$  – may appear to be a needlessly precise measurement of the number three (figure 1a), it today serves as by far the best high-energy constraint on the unitarity of the neutrino mixing matrix. LEP's stash of a million clean tau pairs from  $Z \rightarrow \tau^+ \tau^-$  decays also allowed the universality of the lepton-neutrino couplings to the weak charged current to be tested with unprecedented precision. The present averages are still dominated by the LEP numbers:  $g_\nu/g_\mu = 1.0010 \pm 0.0015$  and  $g_\nu/g_e = 1.0029 \pm 0.0015$ .

LEP continued to carry out Z-lineshape scans until 1991, and repeated them in 1993 and 1995. Two thirds of the total luminosity was recorded at the Z pole. As statistical uncertainties on the Z's parameters went down, the experiments were challenged to control systematic uncertainties, especially in the experimental acceptance and luminosity. Monte Carlo modelling of fragmentation and hadronisation was gradually improved by tuning to measurements in data. On the luminosity front it soon became clear that dedicated monitors would be needed to measure small-angle Bhabha scattering ( $e^+e^- \rightarrow e^+e^-$ ), which proceeds at a much higher rate than Z production. The trick was to design a compact electromagnetic calorimeter with sufficient position resolution to define the geometric acceptance, and to compare this to calculations of the Bhabha cross section.

The final ingredient for LEP's extraordinary precision was a detailed knowledge of the beam energy, which required the four experiments to work closely with accelerator experts. Curiously, the first energy calibration was performed in 1990 by circulating protons in the LEP ring – the first protons to orbit in what would eventually become the LHC tunnel, but at a meagre energy of 20 GeV. The speed of the protons was inferred by comparing the radio-frequency electric field needed to keep protons and electrons circulating at 20 GeV on the same orbit, allowing a measurement of the total magnetic bending field on which the beam energy depends. This gave a 20 MeV uncertainty on the Z mass. To reduce this to 1.7 MeV for the

final Z-pole measurement, however, required the use of resonant depolarisation routinely during data taking. First achieved in 1991, this technique uses the natural transverse spin polarisation of the beams to yield an instantaneous measurement of the beam energy to a precision of  $\pm 0.1$  MeV – so precise that it revealed minute effects caused, for example, by Earth's tides and the passage of local trains (see p40). The final precision was more than 10 times better than had been anticipated in pre-LEP studies.

#### Electroweak working group

The LEP electroweak working group saw the ALEPH, DELPHI, L3 and OPAL collaborations work closely on combined cross-section and other key measurements – in particular the forward-backward asymmetry in lepton and b-quark production – at each energy point. By 1994, results from the SLD collaboration at SLAC were also included. Detailed negotiations were sometimes needed to agree on a common treatment of statistical correlations and systematic uncertainties, setting a precedent for future inter-experiment cooperation. Many tests of the SM were performed, including tests of lepton universality (figure 1b), adding to the tau lepton results already mentioned. Analyses also demonstrated that the couplings of leptons and quarks are consistent with the SM predictions.

The combined electroweak measurements were used to make stunning predictions of the top-quark and Higgs-boson masses,  $m_t$  and  $m_H$ . After the 1993 Z-pole scan, the LEP experiments were able to produce a combined measurement of the Z width with a precision of 3 MeV in time for the 1994 winter conferences, allowing the prediction  $m_t = 177 \pm 13 \pm 19$  GeV where the first error is experimental and the second is due to  $m_H$  not being known. A month later the CDF collaboration at the Tevatron announced the possible existence of a top quark with a mass of  $176 \pm 16$  GeV. Both CDF and its companion experiment D0 reached 5 $\sigma$  “discovery” significance a year later. It is a measure of the complexity of the Z-boson analyses (in particular the

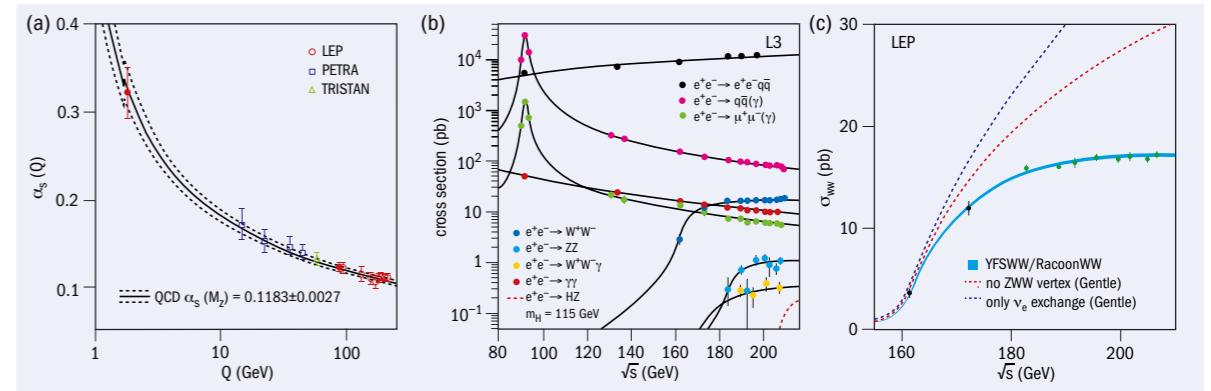

**Fig. 2.** (a) The running of the strong coupling constant, measured both at LEP and in deep-inelastic-scattering experiments, as a function of the energy scale, as predicted by QCD. (b) The LEP physics landscape, starting at the Z peak, above which the cross section is dominated by two-photon reactions ( $e^+e^- \rightarrow e^+e^- q\bar{q}$ ). Other cross sections fall rapidly. The W and Z pair cross-sections become visible at 160 and 182 GeV. No Higgs boson was seen at LEP, excluding the mass range from 15 MeV to 115 GeV. (c) The LEP ring was designed to test the cancellation of the various diagrams for WW production that arise in the electroweak gauge theory. In the absence of electroweak unification, only the neutrino exchange diagram would be present, and the cross section would diverge.

beam-energy measurement) that the final Z-pole results were published a full 11 years later, constraining the Higgs mass to be less than 285 GeV at 95% confidence level (figure 1c), with a best fit at 129 GeV.

#### From QCD to the W boson

LEP's fame in the field tends to concern its electroweak breakthroughs. But, with several million recorded hadronic Z decays, the LEP experiments also made big advances in quantum chromodynamics (QCD). These results significantly increased knowledge of hadron production and quark and gluon dynamics, and drove theoretical and experimental methods that are still used extensively today. LEP's advantage as a lepton collider was to have an initial state that was independent of nucleon structure functions, allowing the measurement of a single, energy-scale-dependent coupling constant. The strong coupling constant  $\alpha_s$  was determined to be  $0.1195 \pm 0.0034$ , at the Z pole, and to vary with energy – the highlight of LEP's QCD measurements. This so-called running of  $\alpha_s$  was verified over a large energy range, from the tau mass up to 206 GeV, yielding additional experimental confirmation of QCD's core property of asymptotic freedom (figure 2a).

Many other important QCD measurements were performed, such as the gluon self-coupling, studies of diffrferences between quark and gluon jets, verification of the running b-quark mass, studies of hadronisation models, measurements of Bose-Einstein correlations and detailed studies of hadronic systems in two-photon scattering processes. The full set of measurements established QCD as a consistent theory that accurately describes the phenomenology of the strong interaction.

Following successful Z operations during the “LEP1” phase in 1989–1995, a second LEP era devoted to accurate studies of W-boson pair production at centre-of-mass energies above 160 GeV got under way. Away from the Z resonance, the electron-positron annihilation cross section decreases sharply; as soon as the centre-of-mass energy reaches twice

the W and Z boson masses, the WW, then ZZ, production diagrams open up (figure 2b). Accessing the WW threshold required the development of superconducting radio-frequency cavities, the first of which were already installed in 1994, and they enabled a gradual increase in the centre-of-mass energy up to a maximum of 209 GeV in 2000.

The “LEP2” phase allowed the experiments to perform a signature analysis, which dated back to the first conception of the machine: the measurement of the WW-boson cross section. Would it diverge or would electroweak diagrams interfere to suppress it? The precise measurement of the WW cross section as a function of the centre-of-mass energy was a very important test of the SM since it showed that the sum and interference of three four-fermion processes were indeed acting in the WW production: the t-channel  $\nu$  exchange, and the s-channel  $\gamma$  and Z exchange (figure 2c). LEP data proved that the  $\gamma$ WW and ZWW triple gauge vertices are indeed present and interfere destructively with the t-channel diagram, suppressing the cross section and stopping it from diverging.

The second key LEP2 electroweak measurement was of the mass and total decay width of the W boson, which were determined by directly reconstructing the decay products of the two W bosons in the fully hadronic ( $W^+W^- \rightarrow qq\bar{q}\bar{q}$ ) and semi-leptonic ( $W^+W^- \rightarrow qq\ell\nu_\ell$ ) decay channels. The combined LEP-W-mass measurement from direct reconstruction data alone is  $80.375 \pm 0.025(\text{stat}) \pm 0.022(\text{sys})$  GeV, the largest contribution to the systematic uncertainties originating from fragmentation and hadronisation uncertainties. The relation between the Z-pole observables,  $m_t$  and  $m_W$ , provides a stringent test of the SM and constrains the Higgs mass.

#### To the Higgs and beyond

Before LEP started, the mass of the Higgs boson was basically unknown. In the simplest version of the SM, involving a single Higgs boson, the only robust constraints were its non-observation in nuclear decays (forbidding masses below 14 MeV) and the need to maintain a sensible, calcu-

**The combined electroweak measurements were used to make stunning predictions of the top quark and Higgs boson masses**

FEATURE LEP'S PHYSICS LEGACY

lable theory (ruling out masses above 1TeV). In 1990, soon after the first LEP data-taking period, the full Higgs-boson mass range below 24 GeV was excluded at 95% confidence level by the LEP experiments. Above this mass the main decay of the Higgs boson, occurring 80% of the time, was predicted to be its decays into b quark-antiquark pairs, followed by pairs of tau leptons, charm quarks or gluons, while the WW\* decay mode starts to contribute at the maximum reachable masses of approximately 115 GeV. The main production process is Higgs-strahlung, whereby a Higgs is emitted by a virtual Z boson.

During the full lifetime of LEP, the four experiments kept searching for neutral and charged Higgs bosons in several models and exclusion limits continued to improve. In its last year of data taking, when the centre-of-mass energy reached 209 GeV, ALEPH reported an excess of four-jet events. It was consistent with a 114 GeV Higgs boson and had a significance that varied as the data were accumulated, peaking at an instantaneous significance of around 3.9 standard deviations. The other three experiments carefully scrutinised their data to confirm or disprove ALEPH's suggestion, but none observed any long-lasting excess in that mass region. Following many discussions, the LEP run was extended until 8 November 2000. However, it was decided not to keep running the following year so as not to impact the LHC schedule. The

final LEP-wide combination excluded, at 95% confidence level, a SM Higgs boson with mass below 114.4 GeV.

The four LEP experiments carried out many other searches for novel physics that set limits on the existence of new particles. Notable cases are the searches for additional Higgs bosons in two-Higgs-doublet models and their minimal supersymmetric incarnation. Neutral scalar and pseudoscalar Higgs bosons lighter than the Z boson and charged Higgs bosons up to the kinematic limit of their pair production were also excluded. Supersymmetric particles suffered a similar fate, in the theoretically attractive assumption of R-parity conservation. The existence of sleptons and charginos was excluded in the largest part of the parameter space for masses below 70-100 GeV, near the kinematic limit for their pair production. Neutralinos with masses below approximately half the Z-boson mass were also excluded in a large part of the parameter space. The LEP exclusions for several of these electroweak-produced supersymmetric particles are still the most stringent and most model-independent limits ever obtained.

It is very hard to remember how little we knew before LEP and the giant step that LEP made. It was often said that LEP discovered electroweak radiative corrections at the level of 50, opening up a precision era in particle physics that continues to set the standard today and offer guidance on the elusive new physics beyond the SM. ●

It is very hard to remember how little we knew before LEP and the giant step that LEP made

**We speak MicroTCA Come talk to us**

Registration & details: [techlab.desy.de/services/training](http://techlab.desy.de/services/training)

Services

- High-end test & measurement services (Analog/Digital Signal Integrity, up to 20 GHz)
- Hardware, firmware & software development
- Timing systems
- Consulting & integration
- Trainings (basic and advanced)

Turn Key Systems

- Low Level RF Controls
- GigE Vision image processing systems
- Industrial test automation & quality control

MicroTCA Training

- Basic building blocks & components
- System assembly & configuration
- System management (incl. MCH and IPMI)
- Communication protocols (e.g. PCI Express, Gigabit Ethernet)
- Timing, triggers & interlocks
- Support for development in MicroTCA
- Troubleshooting procedures

**MICROTCA**  
TECHNOLOGY LAB  
Tel. +49 (0) 8998 1887  
sales-techlab@desy.de  
techlab.desy.de

ADVERTISING FEATURE

Vacuum solutions: it's good to talk

Like many big-science research facilities, the European X-ray Free Electron Laser (European XFEL) has the numbers to impress. The €1.2bn facility, which is located in Hamburg, Germany, uses superconducting linear accelerator technology to generate 27,000 X-ray flashes per second, with a pulse duration of less than 100 fs and a brilliance that's orders of magnitude greater than any other conventional X-ray source.

That unique radiation is put to work in the European XFEL's underground experimental hall, where six scientific instruments enable international teams of researchers and industrial users to carry out a diverse programme of basic and applied materials research – from mapping the atomic details of cells, viruses and biomolecules to time-resolved investigations of chemical reactions and structural imaging of nanoelectronic materials.

Underpinning that collective endeavour and spanning the 3.4 km long facility (XFEL accelerator, X-ray beamlines and the experimental hall) are all manner of enabling vacuum technologies, including chambers and end-stations, CF flange systems, feedthroughs, sample manipulators, valves, pumps and a range of associated hardware and instrumentation.

Building the relationship

The European XFEL's High-Energy Density (HED) instrument is a case in point. Here the XFEL's ultrashort X-ray laser pulses enable fundamental studies of matter at extremes of temperature and pressure – simulating conditions in the interiors of large planets – and at extreme electric or magnetic field strengths.

"Scientists will use the HED instrument to investigate what happens to a material when it's compressed to very high density and changes state from a solid to a plasma," says Ian Thorpe, instrument engineer for the HED programme.

Back in May, Thorpe and his colleagues initiated a series of in-house experiments with the HED instrument – effectively a user-assisted commissioning programme to ensure that the set-up is fit for purpose ahead of full go-live later in the summer. "The first of these experiments successfully characterized the focus," explains Thorpe. "This is critical because we're working on very small samples and you get the highest detail and pressure if you focus the X-ray and optical laser beams into a very tight spot."

In terms of its vacuum specifications, the HED instrument requires a mix of ultrahigh-vacuum and high-vacuum technologies for the X-ray optics/diagnostics enclosure and sample chamber. Many standard catalogue parts are available via the European XFEL's online ordering system, with Kurt J. Lesker Company (KJLC) among the registered suppliers approved by the facility's procurement department.

However, it's KJLC's capabilities in the manufacture and supply of custom vacuum parts, subsystems and chambers that sets the working relationship apart. None of the European XFEL's demands are straightforward, and the delivery of custom vacuum orders relies on a robust feedback loop between manufacturer and customer.

In this way, product specialists and engineers at KJLC review the customer's designs to fully understand the European XFEL's technical requirements and scientific



Under pressure: the HED experimental station will be used to study matter under extreme conditions, including new extreme-pressure phases, solid-density plasmas and phase transitions of complex solids in high magnetic fields. (Courtesy: European XFEL/Jan Hosan)

objectives. The design review, tighter tolerances, cleaning, vacuum test and bake-out are all part of that collaboration with KJLC.

Connected customers

Luis Lopez is a systems integration engineer on another European XFEL experiment, the Single Particles, Clusters and Biomolecules and Serial Femtosecond Crystallography (SPB/SFX) instrument. SPB/SFX is primarily focused on 3D diffractive imaging and structural dynamics (on timescales of milliseconds to femtoseconds) of biological samples such as macromolecules, viruses, organelles and cells.

Although the scientific and vacuum system requirements for SPB/SFX differ from the HED experiment, the SPB/SFX experimental team clearly values the same close working relationship with the KJLC manufacturing division. "We have a direct connection with the product specialists and engineers," says Lopez. "On custom-made parts, that interaction is welcomed, with KJLC staff often coming up with alternative options, improvements and work-arounds to our original designs."

It's all about relationships

Dialogue, trust and, most important of all, listening to your customer. Jonathon Ward, product specialist at KJLC, tells Physics World about the vacuum vendor's forward-looking take on the manufacturer-customer relationship.

What are your priorities when dealing with a big-science customer like the European XFEL?

We want to be the preferred partner for all things vacuum – from a commercial, manufacturing and technology perspective. For me and my colleagues in the manufacturing division, the task is to build relationships and trust with the scientists and engineers at the European XFEL – finding out what they're working on right now but also what they're going to need in three, four, even five years' time. They're thinking about budgets on that timeframe now and that's where we want to position ourselves. Put another way: we're not here for the short term, we're here for the long term.

On a day-to-day basis, what does the operational interaction look like?

It's all about listening to the customer, understanding requirements and ongoing dialogue. For contracts involving bespoke vacuum parts, subsystems and chambers, we'll review the customer's sketches before talking to them about what they're trying to achieve. The job then is to deliver as closely as possible against the technical specifications, delivery time and price. It's often an iterative process – that's what's good about this working relationship. Some technical features we may be able to compromise and trade-off versus others where we might be able to do better than specification.

Are there other ways you look to reinforce the manufacturer-customer relationship?

We recently organized a one-day workshop on fundamental aspects of vacuum science, technology and engineering for the staff at the European XFEL. This is something we've run previously at other European institutions, helping to shape best practice in vacuum applications. It's typically a diverse audience: early-career scientists and engineers as well as staff with lots of experience. There was even someone from purchasing and procurement at the European XFEL event. Our technical director of education, J R Gaines, has years of experience in the field of vacuum science and engineering and this type of forum enables us to share our technical capability, expertise and domain knowledge more widely. At the same time, we're learning new things from our customers. It's a two-way street.

What are the commercial benefits of working with a high-profile customer like the European XFEL?

The European XFEL is at the leading edge of scientific endeavour. If you're a trusted supplier for a customer like them, it opens doors with other big-science initiatives.

**Kurt J. Lesker**  
Company  
[www.lesker.com](http://www.lesker.com)

• The European XFEL gets no commercial advantage from its participation in this article.



Got radiation?  
See what you've been missing

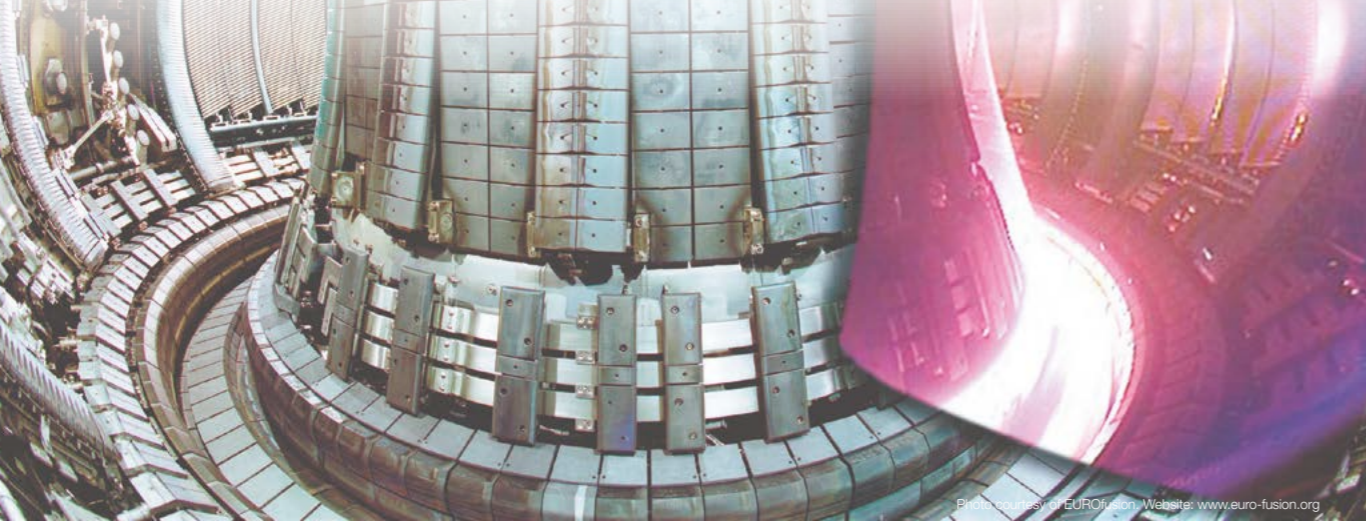

Imaging in radiation environments just got easier

With superior capabilities for operating in radiation environments, the MegaRAD cameras provide excellent image quality well beyond dose limitations of conventional cameras, and are well suited for radiation hardened imaging applications



**MegaRAD3 produce color or monochrome video up to 3 x 10<sup>6</sup> rads total dose**



**MegaRAD1 produce monochrome video up to 1 x 10<sup>6</sup> rads total dose**



**KiloRAD PTZ radiation resistant camera with Pan/Tilt/Zoom**

**In the United States:**

For customer service, call 1-800-888-8761  
To fax an order, use 1-315-451-9421  
Email: sales.cidtec@thermofisher.com

**International:**

For customer service, call [01] 315-451-9410  
To fax an order, use [01] 315-451-9410  
Email: sales.cidtec@thermofisher.com

Find out more at [thermofisher.com/cidtec](http://thermofisher.com/cidtec)

**ThermoFisher**  
SCIENTIFIC

For Research Use Only. Not for use in diagnostic procedures. © 2019 Thermo Fisher Scientific Inc. All rights reserved. All trademarks are the property of Thermo Fisher Scientific and its subsidiaries unless otherwise specified

# THE GREATEST LEPTON COLLIDER

LEP was the highest energy e<sup>+</sup>e<sup>-</sup> collider ever built, with levels of precision that remain unsurpassed in accelerator physics. Former CERN director of accelerators Steve Myers tells LEP's story from conception to its emotional final day.



A few minutes before midnight on a summer's evening in July 1989, 30 or so people were crammed into a back room at CERN's Prévessin site in the French countryside. After years of painstaking design and construction, we were charged with breathing life into the largest particle accelerator ever built. The ring was complete, the aperture finally clear and the positron beam made a full turn on our first attempt. Minutes later beams were circulating, and a month later the first Z boson event was observed. Here began a remarkable journey that firmly established the still indefatigable Standard Model of particle physics.

So, what can go wrong when you're operating 27 kilometres of particle accelerator, with ultra-relativistic leptons whizzing around the ring 11,250 times a second? The list is long. The LEP ring was packed with magnets, power converters, a vacuum system, a control system, a cryogenics system, a cooling and ventilation system, beam instrumentation – and much more. Then there was the control system, fibres, networks, routers, gateways, software, databases, separators, kickers, beam dump, radio-frequency (RF) cavities, klystrons, high-voltage systems, interlocks, synchronisation, timing, feedback... And, of course, the experiments, the experimenters and everybody's ability to get along in a high-pressure environment.

LEP wasn't the only game in town. There was fierce competition from the more innovative Stanford Linear

Collider (SLC) in California. But LEP was off to a fantastic start and its luminosity increase was much faster than at its relatively untested linear counterpart. A short article capturing the transatlantic rivalry appeared in the *Economist* on 19 August 1989. "The results from California are impressive," the magazine reported, "especially as they come from a new and unique type of machine. They may provide a sure answer to the generation problem before LEP does. This explains the haste with which the finishing touches have been applied to LEP. The 27 km-long device, six years in the making, was transformed from inert hardware to working machine in just four weeks – a prodigious feat, unthinkable anywhere but at CERN. Even so, it was still not as quick as Carlo Rubbia, CERN's domineering director-general might have liked."

**Notes from the underground**

LEP's design dates from the late 1970s, the project being led by accelerator-theory group leader Eberhard Keil, RF group leader Wolfgang Schnell and CJ "Kees" Zilverschoon. The first decision to be made was the circumference of the tunnel, with four options on the table: a 30 km ring that went deep into the Jura mountains, a 22 km ring that avoided them entirely, and two variants with a length of 26.7 km that grazed the outskirts of the mountains. Then director-general Herwig Schopper decided on a circumference of 26.7 km with an eye on a future proton collider

**Focus and bend**

*A quadrupole stands next to one of the long dipole magnets that curved electrons and positrons around LEP's 27 km-long ring.*

**THE AUTHOR**

**Steve Myers**  
executive chair of ADAM SA  
(Applications of Detectors and Accelerators to Medicine), Geneva.



FEATURE THE STORY OF LEP

FEATURE THE STORY OF LEP



**Fig. 1.** Blasting the LEP tunnel under the Jura mountains caused water to burst into the tunnel, forming an underground river that took six months to eliminate.

for which it would be “decisive to have as large a tunnel as possible” (CERN Courier July/August 2019 p39). The final design was approved on 30 October 1981 with Emilio Picasso leading the project. Construction of the tunnel started in 1983, after a standard public enquiry in France. LEP’s tunnel, the longest-ever attempted prior to the Channel Tunnel, which links France and Britain, was carved by three tunnel-boring machines. Disaster struck just two kilometres into the three-kilometre stretch of tunnel in the foothills of the Jura, where the rock had to be blasted because it was not suitable for boring. Water burst in and formed an underground river that took six months to eliminate (figure 1). By June 1987, however, part of the tunnel was complete and ready for the accelerator to be installed.

Just five months after the difficult excavation under the Jura, one eighth of the accelerator (octant 8) had been completely installed, and, a few minutes before midnight on 12 July 1988, four bunches of positrons made the first successful journey from the town of Meyrin in Switzerland (point 1) to the village of Sergy in France (point 2), a distance of 2.5 km. Crucially, the “octant test” revealed a significant betatron coupling between the transverse planes: a thin magnetised nickel layer inside the vacuum chambers was causing interference between the horizontal and vertical focusing of the beams. The quadrupole magnets were adjusted to prevent a resonant reinforcement of the effect each turn, and the nickel was eventually demagnetised.

**Giving birth to LEP**

The following months saw a huge effort to install equipment in the remaining 24 km of the tunnel – magnets, vacuum chambers and RF cavities, as well as beam instrumentation, injection equipment, electrostatic separators, electrical cabling, water cooling, ventilation and all the rest. This was followed by conditioning the cavities, baking out and leak-testing the vacuum chambers, and individual testing. At the same time a great deal of effort to prepare the software needed to operate the collider was made with limited resources.

In the late 1980s, control systems for accelerators were going through a major transition to the PC. LEP was caught up in the mess and there were many differences of opinion on how to design LEP’s control system. As July 1989 approached, the control system was not ready and a small team was recruited to implement the bare minimum controls required to inject beam and ramp up the energy.



**Fig. 2.** Physicists pose in front of the final superconducting RF-cavity module to be installed. The modules gradually replaced their normal-conducting predecessors from 1994 to 1999, allowing the centre-of-mass energy to rise during LEP2.

Unable to hone key parameters such as the tune and orbit corrections before beam was injected, we had two major concerns: is the beam aperture clear of all obstacles, and are there any polarity errors in the connections of the many thousand magnetic elements? So we nominated a “Mr Polarity”, whose job was to check all polarities in the ring. This may sound trivial, but with thousands of connections it was a huge task.

At a quarter to midnight on 14 July 1989, the aperture was free of obstacles and the beam made its first turn on our first attempt. Soon afterwards we managed to achieve a circulating beam, and we were ready to fine tune the multitude of parameters needed to prepare the beams for physics.

The goal for the first phase of LEP was electron-positron collisions at a total energy of 91 GeV – the mass of the neutral carrier of the weak force, the Z boson. LEP was to be a true Z factory, delivering millions of Zs for precision tests of the Standard Model. To mass-produce them required beams not only of high energy but also of high intensity, and delivering them required four steps. The first was to accumulate the highest possible beam current at 20 GeV – the injection energy. This was a major operation in itself, involving LEP’s purpose-built injection linac and electron-positron accumulator, the Proton Synchrotron, the Super Proton Synchrotron (SPS) and, finally, transfer lines to inject electrons and positrons in opposite directions – these curved not only horizontally but also vertically as LEP and the SPS were at different heights. The second step was to ramp up the accumulated current to the energy of the Z resonance with minimal losses. Thirdly, the beam had to be “squeezed” to improve the collision rate at the interaction regions by changing the focusing of the quadrupoles on either side of the experiments, thereby reducing the transverse cross section of the beam at the collision points.

Following the highly successful first turn on 14 July 1989, we spent the next month preparing for the first physics run. Exactly a month later, on 13 August, the beams collided

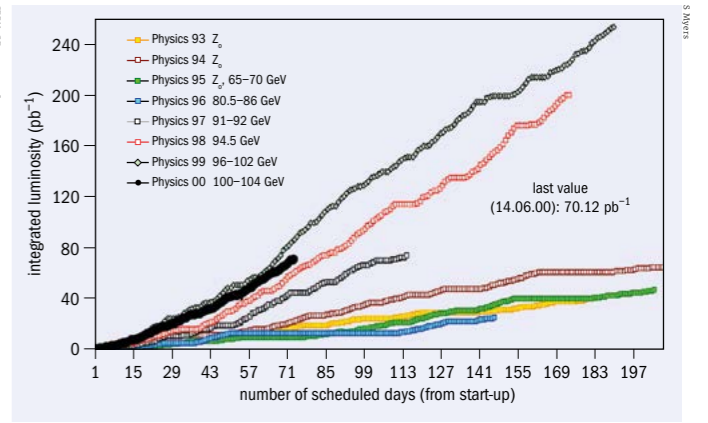

**Fig. 3. Top:** LEP’s integrated luminosity each day from 1993 to 2000. **Left:** LEP surpassed every one of its key design parameters.

LEP1/LEP2 parameters	Design	Achieved
beam energy	55/95 GeV	46/98 GeV
bunch current	0.75 mA	1.00 mA
total beam current	6.0 mA	8.4/6.2 mA
vertical beam-beam parameter	0.03	0.045/0.083
emittance ratio	4.0%	0.4%
maximum luminosity	16/27 10 <sup>30</sup> cm <sup>-2</sup> s <sup>-1</sup>	23/100 10 <sup>30</sup> cm <sup>-2</sup> s <sup>-1</sup>
IP beta function b <sub>x</sub>	1.75 m	1.25 m
IP beta function b <sub>y</sub>	7.0 cm	4.0 cm

**Tidal forces, melting ice and the TGV to Paris**

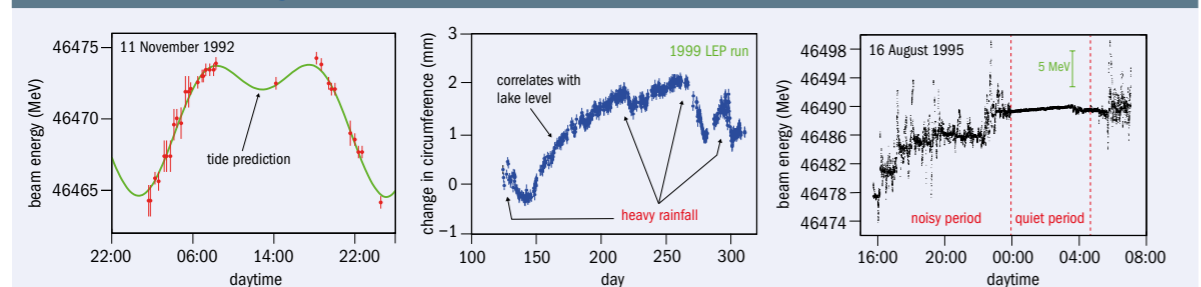

LEP’s exquisite energy resolution meant that physicists had not only to account for tidal (left) and seasonal variations (middle), but also for noise caused by the departure of trains to Paris (right). (Plots by Jorg Wenninger.)

LEP’s beam-energy resolution was so precise that it was possible to observe distortion of the 27 km ring by a single millimetre, whether due to the tidal forces of the Sun and Moon, or the seasonal distortion caused by rain and meltwater from the nearby mountains filling up Lac Léman and weighing down one side of the ring. In 1993 we noticed even more peculiar random variations on the energy signal during the day – with the

exception of a few hours in the middle of the night when the signal was noise free. Everybody had their own pet theory. I believed it was some sort of effect coming from planes interacting with the electrical supply cables. Some nights later I could be seen sitting in a car park on the Jura at 2 a.m., trying to prove my theory with visual observations, but it was very dark and all the planes had stopped landing several hours beforehand.

Experiment inconclusive! The real culprit, the TGV (a high-speed train), was discovered by accident a few weeks later during a discussion with a railway engineer: leakage currents on the French rail track flowed through the LEP vacuum chamber with the return path via the Versoix river back to Cornavin. The noise hadn’t been evident when we first measured the beam energy as TGV workers had been on strike.

FEATURE THE STORY OF LEP

The bizarre episode of the bottles in the beampipe

The story of the sabotage of LEP has grown in the retelling, but I was there in June 1996, hurrying back early from a conference to help the machine operators, who had been struggling to circulate a beam for several days. After exhausting other possibilities, it became clear that there was an obstruction in the vacuum pipe, and we detected the location using the beam position system. It appeared to be around point 1 (where ATLAS now sits), so we opened the vacuum seal and took a look inside the beampipe using mirrors and endoscopes. Not seeing anything, I frustratedly squeezed my head between the vacuum flanges and peered down inside the pipe. In the distance was something resembling a green concave lens. "This looks like the bottom of a beer bottle," I thought, restraining myself from uttering a word to anyone in the vicinity. I went to the opposite open end of the vacuum section and peered into the vacuum pipe again: a green circular disk this time, but again,

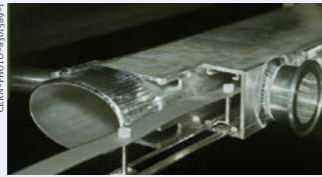

not a word. Someone got a long pole to poke out the offending article – out it came, and my guess was correct: it was a Heineken beer bottle, which had indeed refreshed the parts no other beer could reach, as the slogan ran. A hasty search revealed a second bottle. Upon closer inspection it was clear that the control room operators had almost succeeded in making the beam circulate despite the obstacles: there was a scorch burn along the label, indicating that they had almost managed to steer the beam past the bottles. If there had only been one they may have succeeded. The Swiss police interviewed me concerning this act of sabotage but the culprit was never unmasked.

announced on 13 October, just three months after the final testing of the accelerator's components (see feature on LEP's physics legacy, p32).

LEP dwelt at the Z peak from 1989 to 1995, during which time the four experiments each observed approximately 4.5 million Z decays. In 1995 a major upgrade dubbed LEP2 saw the installation of 288 superconducting cavities (figure 2), enabling LEP to sit at or near the WW threshold of 161 GeV for the following five years. The maximum beam energy reached was 104.4 GeV. There was also a continuous effort to increase the luminosity by increasing the number of bunches, reducing the emittance by adjusting the focusing, and squeezing the bunches more tightly at the interaction points, with LEP's performance ultimately limited by the nonlinear forces of the beam-beam interaction – the perturbations of the beams as they cross the opposing beam. LEP surpassed every one of its design parameters (figure 3).

Life as a LEP accelerator physicist

Being an accelerator physicist at LEP took heart as well as brains. The Sisyphean daily task of coaxing the seemingly temperamental machine to optimal performance even led us to develop an emotional attachment to it. Challenges were unpredictable, such as for the engineers dispatched on a fact-finding mission to ascertain the cause of an electrical short circuit, only to discover two deer, "Romeo and Juliet", locked in a lover's embrace having bitten through a cable, or the discovery of sabotage with beer bottles (see "The bizarre episode of the

bottles in the beampipe"). The aim, however, was clear: inject as much current as possible into both beams, ramp the energy up to 45 GeV, squeeze the beam size down at the collision points, collide and then spend a few hours delivering events to the experiments. The reality was hours of furious concentration, optimisation, and, in the early days, frustrating disappointment.

In the early years, filling LEP was a delicate hour-long process of parameter adjustment, tweaking and coaxing the beam into the machine. On a good day we would see the beam wobble alarmingly on the UV telescopes, lose a bit and watch the rest struggle up the ramp. On a bad day, futile attempt after futile attempt, most of the beam would disappear without warning in the first few seconds of the ramp. The process used to last minutes and there was nothing you could do. We would stand there, watching the lifetime buck and dip, and the painstakingly injected beam would either slowly or quickly drift out of the machine. The price of failure was a turn around and refill. Success brought the opportunity to chance the squeeze – an equally hazardous manoeuvre whereby the interaction-point focusing magnets were adjusted to reduce the beam size – and then perhaps a physics fill, and a period of relative calm. At this stage the focus would move to the experimental particle physicists on shift at the four experiments. Each had their own particular collective character, and their own way of dealing with us. We verged between being accommodating, belligerent, maverick, dedicated, professional and very occasionally hopelessly amateur – sometimes all within the span of a single shift, depending on the attendant pressures.

The experiment teams paraded their operational efficiency numbers – plus complaints or congratulations – at twice weekly scheduling meetings. Well run and disciplined, ALEPH almost always had the highest efficiency figures; their appearances at scheduling meetings nearly always a simple statement of 97.8% or thereabouts. This was livened in later years by the repeated appearance of their coordinator Bolek Pietrzyk, who congratulated us each time we stepped up in energy or luminosity with a strong, Polish-accented, "Congratulations! You have achieved the highest energy electron-positron collisions in the universe!", which was always gratifying. Equally professional, but more relaxed, was OPAL, which had a strong British and German contingent. These guys understood human nature. Quite simply, they bribed us. Every time we passed a luminosity target or hit a new energy record they'd turn up in the control room with champagne or crates of German beer. Naturally we'd do anything for them, happily moving heaven and earth to resolve their problems. L3 and DELPHI had their own quirks. DELPHI, for example, ran their detector as a "state machine", whose status changed automatically based on signals from the accelerator control room. All well and good, but they depended on us to change the mode to "dump beam" at the end of a fill, something that was occasionally skipped, leaving DELPHI's subdetectors on and them ringing us desperately for a mode change. Baffled DELPHI students on shift would ask what was going on. Filling and ramping were demanding periods during the operational sequence

FEATURE THE STORY OF LEP



Fig. 4. Left: media look on as (from left to right) Paul Collier, Mike Lamont and Steve Myers lament LEP's final moments before being decommissioned and replaced by the LHC. Right: the dismantling process began on 13 December 2000. Daniel Regin made the first cut with a hydraulic nibbling machine.



and a lot of concentration was required. The experiment teams did well not to ring and make too many demands at this stage – requests were occasionally rebuffed with a brusque response.

On the verge of a great discovery?

LEP's days were never fated to dwindle. Early on, CERN had a plan to install the LHC in the same tunnel, in a bid to scan ever higher energies and be the first to discover the Higgs boson. However, on 14 June 2000, LEP's final year of scheduled running, the ALEPH experiment reported a possible Higgs event during operations at a centre-of-mass energy of 206.7 GeV. It was consistent with "Higgs-strahlung", whereby a Z radiates a Higgs boson, which was expected to dominate Higgs-boson production in e<sup>+</sup>e<sup>-</sup> collisions at LEP2 energies. On 31 July and 21 August ALEPH reported second and third events corresponding to a putative reconstructed Higgs mass in the range 114–115 GeV.

LEP was scheduled to stop in mid-September with two weeks of reserve time granted to the LEP experiments to see if new Higgs-like events would appear. After the reserve weeks, ALEPH requested two months more running to double its integrated luminosity. One was granted, yielding a 50% increase in the accumulated data, and ALEPH presented an update of their results on 10 October: the signal excess had increased to 2.6σ. Things were really heating up, and on 16 October L3 announced a missing-energy candidate. By now the accelerator team was pushing LEP to its limits, to squeeze out every ounce of physics data in the service of the experiments' search for the elusive Higgs. At the LEP committee meeting on 3 November, ALEPH presented new data that confirmed their excess once again – it had now grown to 2.9σ. A request to extend LEP running by one year was made to the LEPC. There was gridlock, and no unanimous recommendation could be made.

All of CERN was discussing the proposed running of LEP in 2001 to get final evidence of a possible discovery of the

Higgs boson. Arguments against included delays to the start of the LHC of up to three years. There was also concern that Fermilab's Tevatron would beat the LHC to the discovery of the Higgs, and mundane but practical arguments about the transfer of human resources to the LHC and the impact on the materials budget, including electricity costs. The impending closure of LEP, when many of us thought we were about to discover the Higgs, was perceived like the death of a dear friend by most of the LEP-ers. After each of the public debates on the subject a group of us would meet in some local pub, drink a few beers, curse the disbelievers and cry on each other's shoulders. This was the only "civil war" that I saw in my 43 years at CERN.

The CERN research board met again on 7 November and again there was deadlock, with the vote split eight votes to eight. The next day, then director-general Luciano Maiani announced that LEP had closed for the last time. It was a deeply unpopular decision, but history has shown it to be correct: the Higgs was discovered at the LHC 12 years later, with a mass of not 115 but 125 GeV. LEP's closure allowed a massive redeployment of skilled staff, and the experience gained for the first time in running large accelerators went on to prove essential to the safe and efficient operation of the LHC.

When LEP was finally laid to rest we met one last time for an official wake (figure 4). After the machine was dismantled, requiring the removal to the surface of around 30,000 tonnes of material, some of the magnets and RF units were shipped to other labs for use in new projects. Today, LEP's concrete magnet casings can still be seen scattered around CERN as shielding units for antimatter and fixed-target experiments, and even as road barriers.

LEP was the highest energy e<sup>+</sup>e<sup>-</sup> collider ever built. Its legacy was and is extremely important for present and future colliders. The quality and precision of the physics data remain unsurpassed in luminosity, energy and energy calibration. It is the reference for any future e<sup>+</sup>e<sup>-</sup> ring collider design. ●

This was the only civil war that I saw in my 43 years at CERN



# Cryogenic Components

- Cryogenic Control & Shut-off Valves
  - Quench Relief Valves & Current Leads
  - Single & Multi-Line Johnston Couplings
  - Check valves and associated products
- Focusing on cryogenic temperatures **below 100 K**
  - Optimized design for **low operating cost**
  - Suitable to operate in **high magnetic field** and **ionizing radiation**
  - **Long maintenance intervals** and **simple service requirements**
  - More than **40 years of experience**

Liquefaction of gases  
 Gas distribution systems  
 Gas recirculation systems  
 Hydrogen infrastructure  
 Space infrastructure  
 Plasma & fusion research



WEKA AG · Schürlistrasse 8  
 CH-8344 Bäretswil · Switzerland  
 Phone +41 43 833 43 43  
 Fax +41 43 833 43 49  
 info@weka-ag.ch · www.weka-ag.ch

ARCA Flow Group worldwide:  
 Competence in valves, pumps & cryogenics



# OPINION VIEWPOINT

## Building Balkan bridges in theory

Broader European support is vital to preserve and build capacity in fundamental physics in the region of former Yugoslavia and the Balkans, argues Goran Djordjevic.



**Goran Djordjevic** is a theorist at the University of Niš in Serbia and the founding member of SEENET-MTP.

Twenty years ago, distinguished Austrian theorist and co-inventor of supersymmetric quantum field theory, Julius Wess, concluded that something must be done to revitalise science in former Yugoslavia. One of the 12 founding members of CERN, Yugoslavia was a middle-sized European country with corresponding moderate activities in high-energy physics. Its breakup resulted in a dramatic deterioration of conditions for science, the loss of connections and an overwhelming sense of isolation inside the region.

Wess strongly believed that science is a powerful means to influence the development of society. From 1999 to 2003, his initiative “Wissenschaftler in Global Verantwortung” (WIGV), which translates to “Scientists in Global Responsibility”, provided a platform to connect and support individual researchers, groups and institutions with a focus on former Yugoslavia. Much was achieved during this short time, such as the granting of scholarships in mathematics and theoretical physics, a revival of interrupted schools and conferences and the modernisation of intranet at several Serbian institutions. Funding, initially from Germany, provided an opportunity to researchers from former Yugoslavia to establish contacts and cooperation with many excellent researchers from all around the world.

It was natural to expand the WIGV initiative to bridge the gap between southeastern and the rest of Europe. Countries to the east and south of Yugoslavia – such as Bulgaria, Greece, Romania and Turkey – have a reasonably strong presence in high-energy physics. On the other hand, they share some similar economic and scientific problems, with many research groups facing insufficient financing, isolation and lacking critical mass.

Therefore, the participants of the UNESCO-sponsored Balkan Workshop



Networking SEENET-MTP aims to strengthen fundamental physics in southeast Europe.

2003 held in Serbia created the southeastern European Network in Mathematical and Theoretical Physics (SEENET-MTP). The network has since grown to include 16 full and seven associated member institutions from 11 countries, and more than 450 individual members. There are also 13 partner institutions worldwide. During its 15 years SEENET-MTP has undertaken: more than 18 projects, mostly concerning mobility and training; 30 conferences, workshops and schools; more than 300 researcher and student exchanges and fellowships; and more than 250 joint papers. Following initial support from CERN’s theory department, a formal collaboration agreement resulted in the joint CERN-SEENET-MTP PhD Training Program with at least 80 students taking part in the first cycle from 2015 to 2018. Vital support also came from the European Physical Society and ICTP Trieste.

In total, the investment provided for SEENET-MTP from international funds, its members, national funds and in-kind support amounts to almost €1 million. It is quite an achievement – if we consider that the results rely mostly on the efforts and good will of many individuals – but it is still much less than an average “EU project”. This raises important questions about maintaining SEENET-MTP’s efforts.

SEENET-MTP has “thermalised” the system – the network has made people in the region interact. Yet today, we find ourselves asking similar questions that its founders asked themselves 15 years ago. Is there something specific to southeast

Europe that deserves special treatment? Is there something specific in high-energy theoretical physics that merits specific funding? Is the financing of high-energy physics primarily a responsibility of governments? And, if so, can Balkan countries do it properly?

If the answers to the first three questions are “yes”, and to the last one “no”, a pressing issue concerns extra funding and the role of the European Union (EU). In the six or seven countries in the region that are not yet members of the EU (and which have a very unclear perspective about joining), we need to work out how to fund fundamental sciences in a similar way that Poland, Czech Republic, or “older” EU countries do. At the same time, it is important to consider the future roles of non-EU institutions such as CERN and the ICTP. The recent accession of Serbia to CERN as a full member state, and with Croatia and Slovenia in the process of joining, are promising signs towards closer European integration.

Networking is the most natural and promising auxiliary mechanism to preserve and build local capacity in fundamental physics in the region. The next SEENET Scientific-Advisory Committee and its Council meeting will take place at ICTP Trieste from 20 to 23 October. It will be the right place, if not the last possibility, to transfer the initial ideas and achieved results to an EU-supported project to bolster best practice in the Balkans.

● [www.seenet-mtp.info/bridges](http://www.seenet-mtp.info/bridges)

**Is there something specific to southeast Europe that deserves special treatment?**

**FalconX8**  
 POWERED BY SITORO  
 ACCELERATED ANALYSIS

**The World’s Most Advanced Digital Pulse Processor for high-rate Spectroscopy**

- Up to 8 channels of simultaneous processing
- Over 3 Mcps processed by each channel

sales@xia.com  
 Tel: +1-510-401-5760  
[www.xia.com](http://www.xia.com)

**XIA**  
 Instruments That Advance The Art

**JANIS**

**Cryogen Free Probe Stations**

- Applications include nano science, materials and spintronics
- <5 K - 675 K cryocooler-based systems
- Vibration isolated for sub-micron sample stability
- Up to 8 probes, DC to 67 GHz, plus fiber optics
- Zoom optics with camera and monitor
- Horizontal, vertical or vector magnetic field options are available

Other configurations: LHe, LN<sub>2</sub>, room temperature and UHV systems

Contact us today:  
[sales@janis.com](mailto:sales@janis.com)  
[www.janis.com/CryogenFreeProbeStation.aspx](http://www.janis.com/CryogenFreeProbeStation.aspx)  
[www.facebook.com/JanisResearch](https://www.facebook.com/JanisResearch)





## GAS DOSING VALVES for rough to extreme vacuum



SWITZERLAND (HQ) T +41 81 771 61 61 CH@vatvalve.com	USA T +1 800 935 1446 US@vatvalve.com	JAPAN T +81 45 44003 40 JP@vatvalve.com	KOREA T +82 31 662 6856 KR@vatvalve.com	CHINA T +86 21 5032 6658 CN@vatvalve.com
TAIWAN T +886 3 516 90 88 TW@vatvalve.com	SINGAPORE T +65 62525121 SG@vatvalve.com	GERMANY T +49 351 501 93400 DE@vatvalve.com	FRANCE T +33 4 85 88 00 72 FR@vatvalve.com	UNITED KINGDOM T +44 192 645 2753 UK@vatvalve.com

[www.vatvalve.com](http://www.vatvalve.com)

# OPINION INTERVIEW

## Grappling with dark energy

Astrophysicist Adam Riess, who led one of the teams that discovered the accelerating expansion of the universe 20 years ago, discusses intriguing discrepancies in the value of the Hubble constant.

### Could you tell us a few words about the discovery that won you a share of the 2011 Nobel Prize in Physics?

Back in the 1990s, the assumption was that we live in a dense universe governed by baryonic and dark matter, but astronomers could only account for 30% of matter. We wanted to measure the expected deceleration of the universe at larger scales, in the hope that we would find evidence for some kind of extra matter that theorists predicted could be out there. So, from 1994 we started a campaign to measure the distances and redshifts of type-1a supernovae explosions. The shift in a supernova's spectrum due to the expansion of space gives its redshift, and the relation between redshift and distance is used to determine the expansion rate of the universe. By comparing the expansion rates at two different epochs of the universe, we can estimate the expansion rate of the universe and how it changes over time. We made this comparison in 1998 and, to our surprise, we found that instead of decreasing, the expansion rate was speeding up. A stronger confirmation came after combining our measurements with those of the High-z Supernova Search Team. The result could be interpreted if the universe instead of decelerating is speeding up its expansion.

### What was the reaction from your colleagues when you announced your findings?

That our result was wrong! There were understandably different reactions but the fact that two independent teams were measuring an accelerating expansion rate, plus the independent confirmation from measurements of the Cosmic Microwave Background (CMB), made it clear that the universe is accelerating. We reviewed all possible sources of errors including the presence of some yet unknown



**Dark pronouncements** Adam Riess of Johns Hopkins University in the US.

quantum states in the universe produces an enormous number for the expansion rate that is about 120 orders of magnitude higher than observed. This rate is so high that it would have ripped apart galaxies, stars, planets, before any structure was formed.

The accelerating expansion can be due to what we broadly refer to as dark energy, but its source and its physics remain unknown. It is an ongoing area of research. Today we are making further supernovae observations to measure even more precisely the expansion rate, which will help us to understand the physics behind it.

### By which other methods can we determine the source of the acceleration?

Today there is a vast range of approaches, using both space and ground experiments. A lot of work is ongoing on identifying more supernovae and measuring their distances and redshifts with higher precision. Other experiments are also looking to baryonic acoustic oscillations that would provide a standard ruler for measuring cosmological distances in the universe. There are proposals to use weak gravitational lensing, which is extremely sensitive to the parameters describing dark energy as well as the shape and history of the universe. Redshift space distortions due to the peculiar velocities of galaxies can also tell us something. We may be able to learn something from these different types of observations in a few years. The hope is to be able to measure the equation-of-state of dark energy with a 1% precision, and its variation over time with about 10% precision. This will offer a better understanding of whether dark energy is the cosmological constant or perhaps some form of energy temporarily stored in a scalar field that could change over time.

astronomical process, but nothing came out. Barring a series of unrelated mistakes, we were looking at a new feature of the universe.

There were other puzzles at that time in cosmology that the idea of an accelerating universe could also solve. The so-called "age crisis" (many stars looked older than the age of the universe) was one of them. This meant that either the stellar ages are too high or that there is something wrong with the age of the universe and its expansion. This discrepancy could be resolved by accounting for an accelerated expansion.

### What is driving the accelerated expansion?

One idea is that the cosmological constant, initially introduced by Einstein so that general relativity could accommodate a static universe, is linked to the vacuum energy. Today we know that the vacuum energy can't be the final answer because summing the contributions from the presumed

**A new feature in the dark sector of the universe appears increasingly necessary to explain the present tension**



### Wideband Microwave Signal Generators

Standalone and programmable signal generators that fit in your hand. Portable, affordable, reliable.

50MHz to 30GHz Frequency Range	Low Phase Noise
10Hz Frequency Step Size	Ethernet Connection
SCPI Automation Friendly	Ultra-Precision Reference
Intuitive PC Software	Stepped Power Control
USB Powered	Vernier Power Control

Only \$2499



### Mixers With Integrated Local Oscillators

2.5, 6.0, 12, 20, and 30GHz models  
Low conversion loss & leakage  
Wide RF and IF bandwidths  
Internal reference frequency  
Conveniently USB powered & controlled

Starting at \$509<sup>00</sup>



### Wideband Programmable RF Step Attenuators

Up to 90dB of attenuation  
6, 12, 18, 22, and 30GHz bands  
Exceptionally low insertion loss  
USB powered & controlled  
Optional ethernet control

Starting at \$395<sup>00</sup>



**DS INSTRUMENTS**  
WWW.DSINSTRUMENTS.COM



## Magnets for research and medicine

[scanditronix-magnet.se](http://scanditronix-magnet.se)





## CERN COURIER

REPORTING ON INTERNATIONAL  
HIGH-ENERGY PHYSICSGain unique insights on  
the latest research and project  
developments in particle  
physics and related fields

cerncourier.com

## OPINION INTERVIEW

**Is this one of the topics that you are currently involved with?**

Yes, among other things. I am also working on improving the precision of the measurements of the Hubble constant,  $H_0$ , which characterises the present state and expansion rate of our universe. Refined measurements of  $H_0$  could point to potential discrepancies in the cosmological model.

**What's wrong with our current determination of the Hubble constant?**

The problem is that even when we account for dark energy (factoring in any uncertainties we are aware of) we get a discrepancy of about 9% when comparing the predicted expansion rate based on CMB data using the standard "ΛCDM" cosmological model with the present expansion. The uncertainty in this measurement has now gone below 2%, leading to a significance of more than 5σ while future observations from the SH0ES programme would likely reduce it to 1.5%.

There is something more profound in the disagreement of these two measurements. One measures how fast the universe is expanding today, while the other is based on the physics of the early universe – taking into account a specific model – and measuring how fast it should have been expanding. If these values don't agree, there is a very strong likelihood that we are missing something in our cosmological model that connects the two epochs in the history of our universe. A new feature in the dark sector of the universe appears in my view increasingly necessary to explain the present tension.

**When did the seriousness of the  $H_0$  discrepancy become clear?**

It is hard to pinpoint a date, but it was between the publication of first results from Planck in 2013, which predicted the value of  $H_0$  based on precise CMB measurements, and the publication of our 2016 paper that confirmed the  $H_0$  measurement. Since then, the tension has been growing. Various people were convinced along this way as new data came in, while there are people who are still not convinced. This diversity of opinions is a healthy sign for science: we should take into account alternative viewpoints and continuously reassess the evidence that we have without taking anything for granted.

**How can the Hubble discrepancy be interpreted?**

The standard cosmological model, which contains just six free parameters, allows

us to extrapolate the evolution from the Big Bang to the present cosmos – period of almost 14 billion years. The model is based on certain assumptions: that space in the early universe was flat; that there are three neutrinos; that dark matter is very nonreactive; that dark energy is similar to the cosmological constant; and that there is no more complex physics. So one or perhaps a combination of these can be wrong. Knowing the original content of the universe and the physics, we should be able to measure how the universe was expanding in the past and what should be its present expansion rate. The fact that there is a discrepancy means that we don't have the right understanding.

We think that the phenomenon that we call inflation is similar to what we call dark energy, and it is possible that there was another expansion episode in the history of the universe just after the recombination period. Certain theories predict a form of "early dark energy" becomes significant giving a boost to the universe that matches our current observations. Another option is the presence of dark radiation: a term that could account for a new type of neutrino or for another relativistic particle present in the early history of the universe. The presence of dark radiation would change the estimate of the expansion rate before the recombination period and gives us a way to address the current Hubble-constant problem. Future measurements could tell us if other predictions of this theory are correct or not.

**Does particle physics have a complementary role to play?**

Oh definitely. Both collider and astrophysics experiments could potentially reveal either the properties of dark matter or a new relativistic particle or something new that could change the cosmological calculations. There is an overlap concerning the contributions of these fields in understanding the early universe, a lot of cross-talk and blurring of the lines – and in my view, that's healthy.

**What has it been like to win a Nobel prize at the relatively early age of 42?**

It has been a great honour. You can choose whether you want to do science or not, as long as this choice is available. So certainly, the Nobel is not a curse. Our team is continually trying to refine the supernovae measurements, while this is a growing community. Hopefully, if you come back in a couple of years, we will have more answers to your questions.

Interview by **Panos Charitos** CERN.

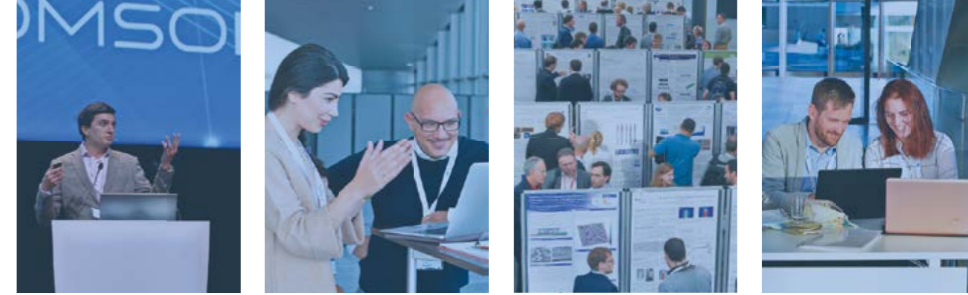
COMSOL  
CONFERENCE  
2019 CAMBRIDGE24–26 SEPTEMBER  
CHURCHILL COLLEGEExplore the latest innovation and techniques in  
**multiphysics simulation.**

Join us at the COMSOL Conference 2019 where you'll get a firsthand look at how innovators in your field are adopting multiphysics modelling and simulation applications, learn new technical skills and gain inspiration for your next project.

MINICOURSES | PANEL DISCUSSIONS | KEYNOTE TALKS | EXHIBITION

► Learn more and register today at [comsol.com/conference/cambridge](https://comsol.com/conference/cambridge)



**STAY CONNECTED**  
**RESTEZ CONNECTÉS**

<http://alumni.cern>

 The High-Energy Network  
Le Réseau des hautes énergies

**The new generation scintillator /  
Sipm detectors**

- Compact
- Low power (5 V , 5 mA)
- Built-in temperature compensated bias generator / preamplifier
- PMT readout comparable energy resolution
- Wide choice of scintillator



SCIONIX Holland B.V.  
Tel. +31 30 6570312  
Fax. +31 30 6567563  
Email. [sales@scionix.nl](mailto:sales@scionix.nl)  
[www.scionix.nl](http://www.scionix.nl)

**Contact us for  
more information**



# SUPERCON, Inc.

## Superconducting Wire and Cable

Standard and Specialty designs are available to meet your most demanding superconductor requirements.

SUPERCON, Inc. has been producing niobium-based superconducting wires and cables for half a century. We are **the original SUPERCON** – the world’s first commercial producer of niobium-alloy based wire and cable for superconducting applications.

### Standard SC Wire Types

- NbTi Wires
- Nb<sub>3</sub>Sn — Bronze
- Nb<sub>3</sub>Sn — Internal Tin
- CuNi resistive matrix wires
- Fine diameter SC Wires
- Aluminum clad wire
- Wire-in-Channel
- Innovative composite wires

### Product Applications

- Magnetic Resonance Imaging
- Nuclear Magnetic Resonance
- High Energy Physics
- SC Magnetic Energy Storage
- Medical Therapeutic Devices
- Superconducting Magnets and Coils
- Crystal Growth Magnets
- Scientific Projects

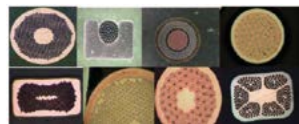

**“We deliver superconductivity!”**

Contact us at [sales@supercon-wire.com](mailto:sales@supercon-wire.com)  
[www.SUPERCON-WIRE.com](http://www.SUPERCON-WIRE.com)

# OPINION REVIEWS

## The cutting edge of cancer research

### The Physics of Cancer

By **Caterina A M La Porta and Stefano Zapperi**

Cambridge University Press

Cancer is a heterogeneous phenomenon that is best viewed as a complex system of cells interacting in a changing micro-environment. Individual experiments may fail to capture this reality, given spatially and temporally limited scales of observation, however, in recent years, physicists have contributed insights into the interplay of phenomena at different scales: gene regulatory networks and communities of cells or organisms are two examples of systems whose properties emerge from the behaviour of individual components. Unfortunately, however, such research is usually confined to journals and specialised conferences, hindering the entry of interested physicists into the field. The publication of a new interdisciplinary textbook is therefore most welcome.

La Porta and Zapperi’s *The Physics of Cancer*, one of the few books devoted to this subject, brings 15 years of exciting and important results in cancer research to a wide audience. The book approaches the subject from the perspective of physics, chemistry, mathematics and computer science. As a result of the vastness of the subject and the brevity of the book, the discussion can occasionally feel superficial, but the main concepts are introduced in a manner accessible to physicists. The authors follow a logical thread within each argument, and furnish the reader with abundant references

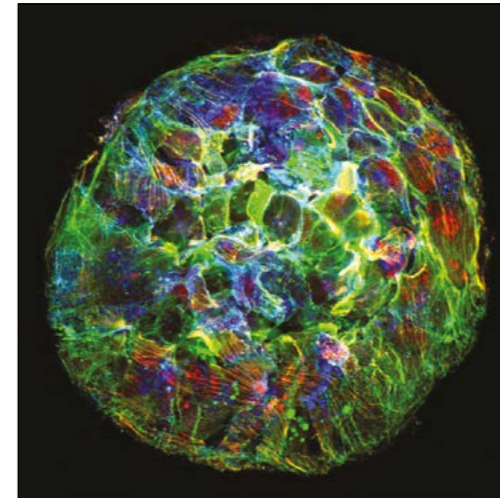

handful of concepts is formidable. However, La Porta and Zapperi argue that a more abstract and unifying approach is now needed to gain a deeper understanding. They advocate studying cancer as a complex system with the tools of several disciplines, in particular sub-fields of physics such as biomechanics, soft-condensed-matter physics and statistical mechanics.

The book is structured in 10 self-contained chapters. The first two present essential notions of cell and cancer biology. The subsequent chapters deal with different features of cancer from an interdisciplinary perspective. A discussion on statistics and computational models of cancer growth is followed by a chapter exploring the generation of vascular networks in its biological, hydrodynamical and statistical aspects. Next comes a mathematical discussion of tumour growth by stem cells – the active and self-differentiating cells thought to drive the growth of cancers. A couple of chapters treat the biomechanics of cancer cells and their migration in the body, before La Porta and Zapperi turn to the dynamics of chromosomes and the origin of the genetic mutations that cause cancer. The final two chapters focus on how to fight tumours, from the perspectives of both the immune system and pharmacological agents.

**Cancer physics**  
*Breast cancer cells attached to a surface rich in collagen.*

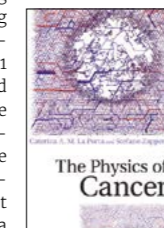

La Porta and Zapperi’s book isn’t just light reading for curious physicists – it can also serve to guide interested researchers into a rich interdisciplinary area.

**Guido D’Amico** *Stanford University and Università di Parma.*

to the original literature.

The book begins by observing that the “hallmarks” of cancer are not only yet to be understood, but have increased in number. Published at the turn of the millennium, Douglas Hanahan and Robert Weinberg’s seminal paper identified six: sustaining proliferative signalling; evading growth suppressors; enabling replicative immortality; activating invasion and metastasis; inducing angiogenesis; and resisting cell death. Just 11 years later the same authors published an updated review adding four more hallmarks: avoiding immune destruction; promoting inflammation; genome instability and mutation; and deregulating cellular energetics. The amount of research that has been distilled into a

### CERN and the Higgs Boson: The Global Quest for the Building Blocks of Reality

By **James Gillies**

Icon Books

James Gillies’ slim volume *CERN and the Higgs Boson* conveys the sheer excitement of the hunt for the eponymous particle. It is a hunt that had its origins at

**There is, perhaps, an excessively glossy presentation of progress**

the beginning of the last century, with the discovery of the electron, quantum mechanics and relativity, and which was only completed in the first decades of the next. It is also a hunt throughout which CERN’s science, technology and culture grew in importance. Gillies has produced a lively and enthusiastic text that explores the historical, theoretical, experimental, technical and political aspects of the search for the Higgs boson without going into oppressive scientific

detail. It is rare that one comes across a monograph as good as this.

Gillies draws attention to the many interplays and dialectics that led to our present understanding of the Higgs boson. First of all, he brings to light the scientific issues associated with the basic constituents of matter, and the forces and interactions that give rise to the Standard Model. Secondly, he highlights the symbiotic relationship between theoretical and experimental

**Hilger Crystals**  
 A Dynasil Company

**Dense, Bright, Fast Crystals for your World-Class Research**

State-of-the-art scintillation and detection solutions

- Crystals:** Grown to spec within short lead times
- Arrays:** Linear and 2D from 5mm to 200mm
- Detectors:** Single units and complete assemblies (PMT, CCD, and SiPM)

#### Materials Index

BGO	Cs2LiYCl6(Ce)	CsI
CsI (Na)	CaF2(Eu)	NaI
GLuGAG	CsI (TI)	NaI (TI)
LYSO	CdWO4	ZnWO4

#### CONTACT US TODAY:

[sales@hilger-crystals.co.uk](mailto:sales@hilger-crystals.co.uk)  
 +44 1843 231166  
[hilger.dynasil.com](http://hilger.dynasil.com)

#### MEET US AT:

SCINT Booth 21	IEEE NSS & MIC Booth 505
----------------	--------------------------

Free shipping when you mention **CERN19**

**Exir Broadcasting**

YOUR PARTNER FOR PASSIVE RF COMPONENTS

TRANSMISSION LINES, COAXIAL & WAVEGUIDE

PATCH PANELS & SPLITTERS

CUSTOMISED RF COMPONENTS

[www.exirbroadcasting.com](http://www.exirbroadcasting.com)

Exir Broadcasting AB  
 Industrigatan 17 - SE-242 31 Hörby - Sweden  
 +46 415 30 14 00 - [info@exirbroadcasting.com](mailto:info@exirbroadcasting.com)



## OPINION REVIEWS

research, each leading the other in turn, and taking the subject forward. Finally, he shows the inter-development of the accelerators, detectors and experimental methods to which massive computing power had eventually to be added. This is all coloured by a liberal sprinkling of anecdotes about the people that made it all possible.

Complementing this is the story of CERN, both as a laboratory and as an institution, traced over the past 60 years or so, through to its current pre-eminent standing. Throughout the book the reader learns just how important the people involved really are to the enterprise: their sheer pleasure, their commitment through the inevitable ups and downs, and their ability to collaborate and compete in the best of ways.

A ripping yarn, then, which it might seem churlish to criticise. But then again, that is the job of a reviewer. There is, perhaps, an excessively glossy presentation of progress, and the exposition continues forward apace without conveying the many downs of cutting-edge research: the technical difficulties and the many

immensely hard and difficult decisions that have to be made during such enormous endeavours. Doing science is great fun but also very difficult – but then what are challenges for?

A pertinent example in the Higgs-boson story not emphasised in the book occurred in 2000. The Large Electron Positron collider (LEP) was due to be closed down to make way for the LHC, but late in the year LEP's ALEPH detector recorded evidence suggesting a Higgs boson might be being observed at a mass of 114–115 GeV – although, unfortunately, not seen by the other experiments (see p32). Exactly this situation had been envisaged when not one but four LEP experiments were approved in the 1980s. After considerable discussion LEP's closure went ahead, much to the unhappiness and anger of a large group of scientists who believed they were on the verge of a great discovery. This made for a very difficult environment at CERN for a considerable time thereafter. We now know the Higgs was found at the LHC with a mass of 125 GeV, vindicating the original decision of 2000.

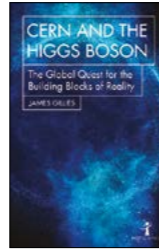

A few more pictures might help the text and fix the various contributors in readers' minds, though clearly the book, part of a series of short volumes by Icon Books called *Hot Science*, is formatted for brevity. I also found the positioning of the important material on applications such as positron emission tomography and the world wide web to be unfortunate, situated as it is in the final chapter, entitled "What's the use?" Perhaps instead the book could have ended on a more upbeat note by returning to the excitement of the science and technology, and the enthusiasm of the people who were inspired to make the discovery happen.

*CERN and the Higgs Boson* is a jolly good read and recommended to everyone. Whilst far from the first book on the Higgs boson, Gillies' offering distinguishes itself with its concise history and the insider perspective available to him as CERN's head of communications from 2003 to 2015: the denouement of the hunt for the Higgs.

**Roger Cashmore** University of Oxford.

## Subatomic Desire

Audiovisual performance, CERN, 21 June

Swiss composer Alexandre Traube and the Genevan video-performer Silvia Fabiani have collaborated to form music and dance troupe *Les Atomes Dansants*, with the aims of using CMS data to explore the links between science and art, and establishing a dialogue between Eastern and Western culture. Premiering their show *Subatomic Desire* at CERN's Globe of Science and Innovation on 21 June during Geneva's annual Fête de la Musique, they took the act to the detector that served as their muse, performing in the hangar above the CMS experiment.

Muon tracks from W, Z and Higgs events served as inspiration for Traube, who was advised by CMS physicist Chiara Mariotti of INFN. He began by associating segments of CMS's muon system to notes. Inspired by the detectors' arrangement as four nested dodecagons, he assigned a note from the chromatic scale to each of the 12 sides of the innermost layer, and the note a sonorous perfect fourth above to the corresponding segment in the outer layer. Developing an initial plan to link the intermediate two layers of the muon

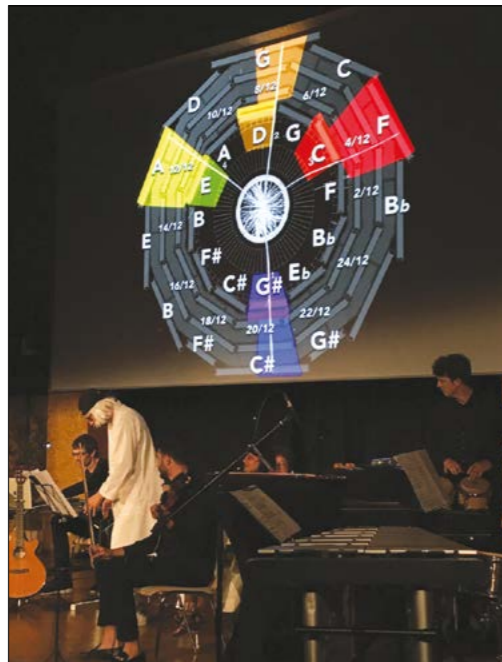

**Subatomic desire**  
*Les Atomes Dansants* were inspired by muon tracks at the CMS experiment.

system to specific frequencies as well, he linked two intermediate microtonal notes to the transverse momentum and rapidity of the tracks. At several moments during the performance the musicians improvise using the resulting

four-note sequences: an expression of quantum indeterminacy, according to Traube. Fabiani's video projections add to the surreal atmosphere by transposing the sequences into colours, with an animation of bullets referencing the Russian World War II navy shells that were used to build CMS's hadronic calorimeter.

In concert with the audiovisual display, three performers sing about their love for the microcosm. Clad in lab coat, Einstein wig and reversed baseball cap, Doc MC Carré (David Charles) raps formulas and boogies around the stage. He is accompanied by Doc Lady Emmy, played by the soprano Marie-Najma Thomas, and Poète Atomique – the Persian singer Taghi Akhabari – who peppers the performance with mystical extracts from Sufi poets Rûmi and Attâr, and medieval German abbess Hildegard of Bingen, each of whom explores themes of the natural world in their writings. The performers contend that the lyrics speak about desire as the fuel for everything at the micro- and macro-scale. Elaborate, contemporary and rich in metaphors, this is an experience that some will find abstruse, but others will love.

*Subatomic desire* will next be performed in Neuchâtel on 14 September.

**Letizia Diamante** CERN.

## PEOPLE CAREERS

## From SUSY to the boardroom

Beginning as a student discussion in the CERN cafeteria five years ago, ProtonMail has become the leading provider of secure e-mail and a challenger of online business models.

Former particle physicist Andy Yen has set himself a modest goal: to transform the business model of the internet. In the summer of 2013, following the Snowden security leaks, he and some colleagues at CERN started to become concerned about the lack of data privacy and the growing inability for individuals to control their own data on the internet. It prompted him, at the time a PhD student from Harvard University working on supersymmetry searches in the ATLAS experiment, and two others to invent "ProtonMail" – an ultra-secure e-mail system based on end-to-end encryption.

The *Courier* met with Yen and Bart Butler, ProtonMail's chief technology officer and fellow CERN alumnus, at the company's Geneva headquarters to find out how out a discussion in CERN's Restaurant 1 was transformed into a company with more than 100 employees serving more than 10 million users.

"The business model of the internet today really isn't compatible with privacy," explains Yen. "It's all about the relationship between the provider and customer. If you are a Gmail user then you are not Google's customer, you are the product that Google sells to its real customer, which is advertisers. With ProtonMail, the people who are paying us are also our users. If we were ever to betray the trust of the user base, which is paying us precisely for reasons of

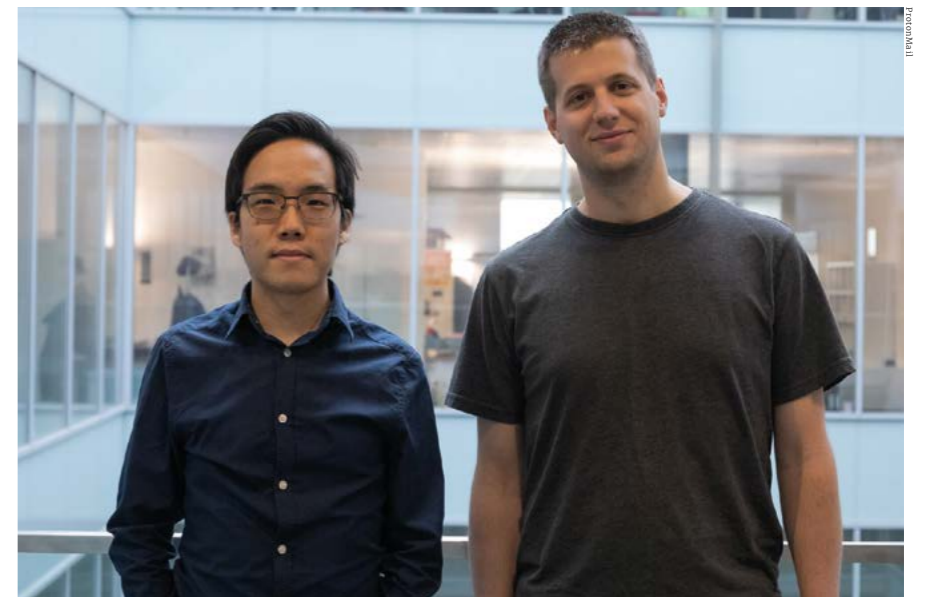

**Noble goals** ProtonMail CEO Andy Yen (left) and CTO Bart Butler, photographed at the company's head office in Geneva in March, want internet users to be more aware of how their personal data is being used.

privacy, then the whole business model collapses."

Anyone can sign up for a ProtonMail account. Doing so generates a pair of public and private keys based on secure "RSA"-type encryption implementations and open-source cryptographic libraries. User data is encrypted using a key that ProtonMail does not have access to, which means the company cannot decrypt or access a user's messages (nor offer data recovery if a password is forgotten). The challenge, says Yen, was not so much in developing the underlying algorithms, but in applying this level of security to an e-mail service in a user-friendly way.

In 2014, Yen and ProtonMail's other cofounders, Jason Stockman and Wei Sun, entered a competition at MIT to pitch the idea. They lost, but reasoned that they had already built the thing and got a

couple of hundred CERN people using it, so why not open it up to the world and see what happens? Within three days of launching the website, 10,000 people had signed up. It was surprising and exciting, says Yen, but also scary. "E-mail has to work. A bank or something might close down their websites for an hour of maintenance once in a while, but you can't do that with e-mail."

ProtonMail's CERN origins (the name came from the fact that its founders were working on the Large Hadron Collider) meant that the technology could first come under the scrutiny of technically minded people – "early adopters", who play a vital role in the lifecycle of new products. But what might be acceptable to tech-minded people is not necessarily what the broader users want, says Yen. He quickly realised that the company

had to grow, and that he had been forced into a "tough and high-risk" decision between ProtonMail and his academic career. Eventually deciding to take the leap, Harvard granted him a period of absence, and Yen set about dealing with the tens of thousands of users who were waiting to get onto the service.

In need of cash, the fledgling software outfit decided to try something unusual: crowd funding. This approach broke new ground in Switzerland, and ProtonMail soon became a test case in tax law as to whether such payments should be considered revenue or donation (the authorities eventually ruled on the former). But the effort was a huge success, raising 0.5 million Swiss Francs in a little over two months. "Venture capital (VC) was a mystery to us," says Yen. "We didn't know anybody, we didn't have a business plan, we were just a few >



PEOPLE CAREERS

people writing code. But, funnily enough, the crowd sourcing, in addition to the money itself, got a lot of attention and this attracted interest from VCs." A few months later, ProtonMail had received 2 million Swiss Francs in seed funding.

– then we had to actually do what we'd promised: build a team, hire people, scale up the product, and have some sort of company to run things, with corporate identity, accounting, tax compliance etc. There wasn't really a marketing plan... it was more of a technical challenge to build the service,"

says Yen. "If I was to give advice to someone in my position five years ago, then there isn't a lot I could say. Starting a company is something new for almost everybody who does it, and I don't think physicists are at a disadvantage compared to someone who went to business school. All you have to do is work hard, keep

learning and you have to have the right people around you."

It was around that time, in 2015, when Butler, also a former ATLAS experimentalist working on super-symmetry and one-time supervisor of Yen, joined ProtonMail. "A lot of that year was based around evolving the product, he says. "There was big difference between what the product originally was versus what it needed to be to scale up. It's not a traditional company – 10-15% of the staff today is CERN scientists. A lot of former physicists have developed into really good software engineers, but we've had to bring in properly trained software engineers to add the rigour that we need. At the end of the day, it's easier to teach a string theorist how to code than it is to teach advanced mathematics and complex cryptographic concepts to someone who codes."

With the company, Proton Technologies, by then well established – and Yen having found time to hot-foot it back to Harvard for one "very painful and ridiculous" month to write up his PhD thesis – the next milestone came in 2016 when ProtonMail was actually launched. It was time to begin charging for accounts, and to provide those who already had signed up with premium paid-for services. It was the ultimate test of the business model: would enough people be prepared to pay for secure e-mail to make ProtonMail a viable and even profitable business? The answer turned out to be "yes", says Yen. "2016 was make or break because eventually the funding was going to run out. We discussed whether we should raise money to buy us more time. But we decided just to work our asses off instead. We came very close but we started generating revenue just as the VC cash ran out."

Since then, ProtonMail has continued to scale up its services, for instance introducing mobile apps, and its user base has grown to more than 10 million. "Our main competitors are the big players, Google and Microsoft," says Yen. "If you look at what Google offers today, it's actually really nice to use. So the longer vision is: can we offer what Google provides — services that are secure, private and beneficial to society? There is a lot to build there, ProtonDrive, ProtonCalendar, for example, and we are working to

## PT2026 NMR Precision Teslameter

# Reach new heights in magnetic field measurement

The Metrolab PT2026 sets a new standard for precision magnetometers. Leveraging 30 years of expertise building the world's gold standard magnetometers, it takes magnetic field measurement to new heights: measuring higher fields with better resolution.

The PT2026 offers unprecedented flexibility in the choice of parameters, interfacing and probe placement, as well as greatly improved tolerance of inhomogeneous fields. And with Ethernet & USB interfaces and LabVIEW software, it fits perfectly into modern laboratory environments.



www.agence-arca.com - Photo: Scott Maxwell, Masterfile



**Metrolab**  
Magnetic precision has a name

www.metrolab.com

INSTRUMENTATION TECHNOLOGIES
LIBERA

**LIBERA BEAM LOSS MONITOR SYSTEM**

- **Consists of:** plastic scintillator-based beam loss detector and dedicated electronics
- **Sensitive to:** X-rays, Gamma-rays, electrons, protons and neutrons
- **Where to use:** LINAC, transfer lines, storage rings, extraction lines
- **Main functions:** ADC raw data, loss integration / averaging / counting over user-configurable time intervals
- **Interfaces:** EPICS, Tango, TCP-IP, Web-Server and command-line

**SCAN AND TRY OUT FOR FREE!**

Instrumentation Technologies, d.o.o. / Velika pot 22, SI-5250 Solkan, Slovenia / e: sales@i-tech.si / w: www.i-tech.si

## Multiphysics simulation aids in predicting laser cavity stability.

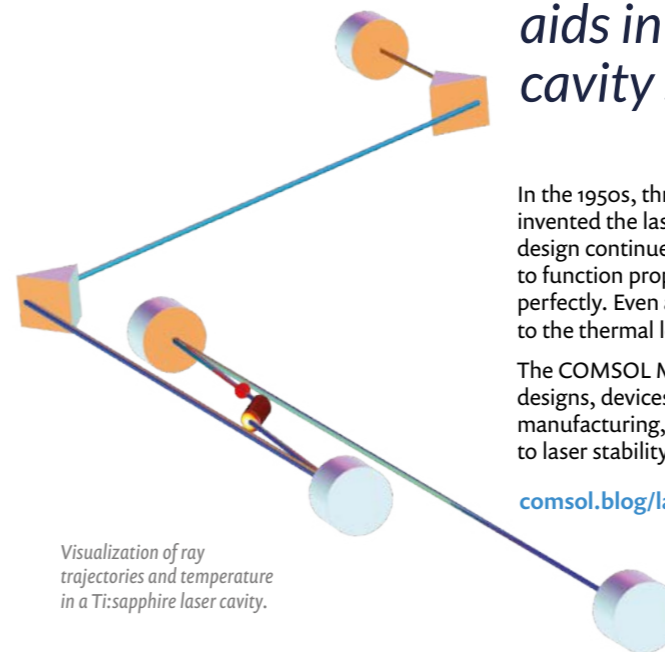

Visualization of ray trajectories and temperature in a Ti:sapphire laser cavity.

In the 1950s, three scientists engaged in a patent war over who invented the laser. We've come a long way since then, but laser design continues to be challenging work. In order for lasers to function properly, their cavity mirrors have to be aligned perfectly. Even after lasing for a while, they can stop working due to the thermal lensing effect. Simulation can help.

The COMSOL Multiphysics® software is used for simulating designs, devices, and processes in all fields of engineering, manufacturing, and scientific research. See how you can apply it to laser stability analysis.

[comsol.blog/laser-stability](http://comsol.blog/laser-stability)



PEOPLE CAREERS

put together that whole ecosystem.” A big part of the battle ahead is getting people to understand what is happening with the internet and their data, says Butler. “Nobody is

saying that when Google or Facebook began they went out to grab people’s data. It’s just the way the internet evolved: people like free things. But the pitfalls of this

model are becoming more and more apparent. If you talk to consumers, there is no choice in the market. It was just e-mail that sold your data. So we want to provide that private

option online. I think this choice is really important for the world and it’s why we do what we do.”

**Matthew Chalmers** editor.

Appointments and awards



The fourth edition of the Guido Altarelli Award, which recognises exceptional achievements from young scientists in the field of deep inelastic scattering and related subjects, was awarded during the DIS2019 workshop in Torino, Italy, on 8 April. Jonathan Gaunt of CERN was recognised for his pioneering contributions to the theory and phenomenology of double and multiple parton scattering. Josh Bendavid, also



Higgs boson and top quark. The Julius Wess Award is endowed with €10,000 and is granted annually to elementary particle and astroparticle physicists for exceptional experimental or theoretical scientific achievements.

ICTP announces next director

Atish Dabholkar, a theorist from India, has been appointed the next director of the International Centre for Theoretical Physics (ICTP) in Trieste, Italy. Currently head of ICTP’s high-energy, cosmology and astroparticle physics section, Dabholkar will take up his new position in November. He will succeed Fernando Quevedo, who has led the centre since 2009. Dabholkar’s research has focused on string theory and quantum black holes, and his appointment comes at a time of expansion for ICTP. Over the past 10 years, the centre has hired more researchers and created new research initiatives in quantitative life sciences, high-performance computing, renewable energies and quantum technology. In addition, ICTP has increased its presence with the opening of four partner institutes in Brazil, China, Mexico and Rwanda. “Directing ICTP is a once in a lifetime opportunity due to its unique mission and its big impact in developing countries. I am glad that when I leave in November the institute will be in very good hands,” says Quevedo.

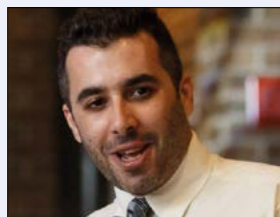

CERN, and a member of the CMS collaboration, received the award for his innovative contributions with original tools to Higgs physics and proton parton density functions at the LHC. The brother of the late Guido Altarelli, Massimo Altarelli, was present at the ceremony and handed the certificates to the two winners.



Winners of 2019 Beamline for Schools competition

Two teams of high-school students, one from the Praedinius Gymnasium in Groningen, Netherlands (below), and one from the West High School in Salt Lake City, US, have won CERN’s 2019 Beamline for Schools competition. In October, the teams will travel to DESY in Germany to carry out their proposed experiments together with scientists from CERN and DESY. The Netherlands team “Particle Peers” will compare the properties of the particle showers originating from electrons with those created from positrons, while the “DESY Chain” team from the US will focus on the properties of scintillators for more efficient particle detectors. Since Beamline for Schools was launched in 2014,



combining microscopic physics with the large-scale structure of the universe”.

Julius Wess Award 2018

Sally Dawson of Brookhaven National Laboratory has been granted the 2018 Julius Wess Award by the KIT Elementary Particle and Astroparticle Physics Center of Karlsruhe Institute of Technology. She is recognised for her outstanding scientific contributions to the theoretical description and in-depth understanding of processes in hadron colliders, in particular her work relating to the physics of the



almost 10,000 students from 84 countries have participated. This year, 178 teams from 49 countries worldwide submitted a proposal for the sixth edition of the competition. Due to the current long shutdown of CERN’s accelerators for maintenance and upgrade, there is currently no beam at CERN, which has opened up opportunities to explore partnerships with DESY and other laboratories.

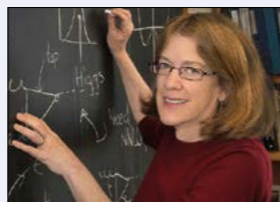

Guido Altarelli Award 2019



and Rashid Sunyaev (Max Planck Institute for Astrophysics) share the prize for “their outstanding contributions to the physics of the cosmic microwave background with experimentally tested implications that have helped to transform cosmology into a precision scientific discipline by

IOP | ebooks™

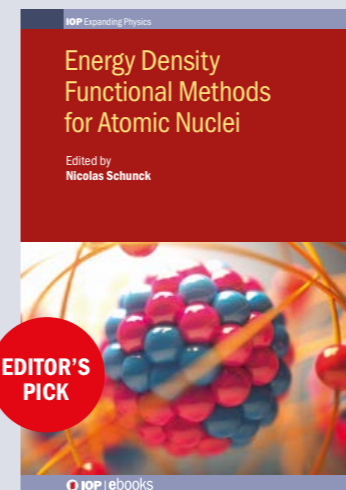

Energy Density Functional Methods for Atomic Nuclei

Edited by **Nicolas Schunck**

In the past 20 years, energy density functional (EDF) approaches have become a powerful framework to study the structure and reactions of atomic nuclei. This book provides an updated presentation of non-relativistic and covariant energy functionals, single- and multi-reference methods, and techniques to describe small- and large-amplitude collective motion or nuclei at high excitation energy. Detailed derivations, practical approaches, examples and figures are used throughout the book to give a coherent narrative of topics that have hitherto rarely been covered together.

**Nicolas Schunck** is research scientist at Lawrence Livermore National Laboratory. His work is centred on the development and applications of computational methods for nuclear energy density functional theory, with a particular focus on the development of a fundamental description of nuclear fission.

EDITOR'S PICK

To access this title visit [topscience.org/books](http://topscience.org/books). If you have an idea for a book you'd like to discuss please e-mail [ebooks@ioppublishing.org](mailto:ebooks@ioppublishing.org).

IOP Publishing | science first



Journal of Physics G Nuclear and Particle Physics

New open access agreement with CERN

Journal of Physics G: Nuclear and Particle Physics is now fully compliant with the CERN publication policy, making it even easier to publish with us.

Submit your next article and enjoy the quality and service of our community-led journal.

[iopscience.org/jphysg](http://iopscience.org/jphysg)

Image: inspired by a figure in the first issue published in 1975, in celebration of its 40th anniversary  
D D Warner et al 1975 J. Phys. G: Nucl. Phys. 1 95

IOP Publishing | science first



# RECRUITMENT

For advertising enquiries, contact *CERN Courier* recruitment/classified, IOP Publishing, Temple Circus, Temple Way, Bristol BS1 6HG, UK. Tel +44 (0)117 930 1264. E-mail [sales@cerncourier.com](mailto:sales@cerncourier.com). Please contact us for information about rates, colour options, publication dates and deadlines.

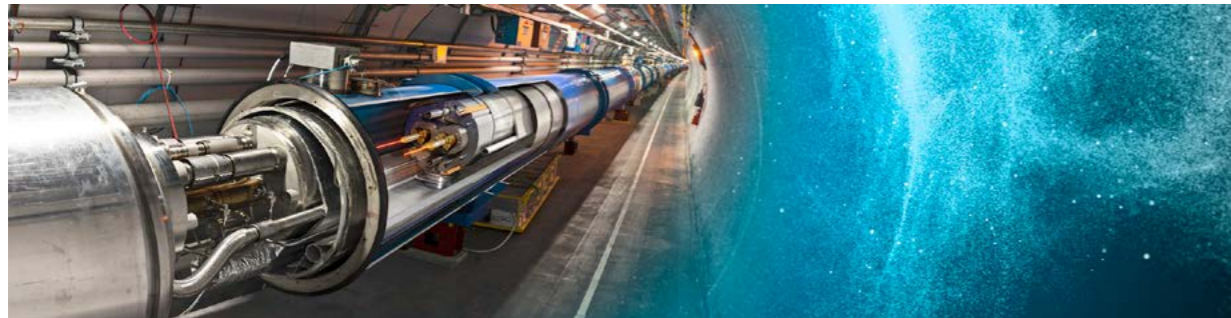

## Accelerate your career!

Join CERN for a unique work experience at the cutting edge of technology, in a place like nowhere else on earth.

CERN has diverse student, graduate and professional opportunities open for application.

Apply now and take part!

<https://careers.cern>



### PAUL SCHERRER INSTITUT



The Paul Scherrer Institute PSI is the largest research institute for natural and engineering sciences within Switzerland. We perform cutting-edge research in the fields of matter and materials, energy and environment and human health. By performing fundamental and applied research, we work on sustainable solutions for major challenges facing society, science and economy. PSI is committed to the training of future generations. Therefore about one quarter of our staff are post-docs, post-graduates or apprentices. Altogether PSI employs 2100 people.

For use at the Swiss Light Source (SLS) and SwissFEL - two of the most advanced X-Ray radiation sources worldwide - the Photon Science Detector Group develops one- and two-dimensional high speed X-Ray detectors with frame rates of several kHz. For the design of single photon counting and charge integrating readout chips for hybrid strip and pixel detectors we are looking for a

### Chip Designer (Detector Development Photon Science Division)

#### Your tasks

- Work on chip design for XFEL- and Synchrotron detectors in collaboration with other chip designer in the Group and with the responsibility for a readout chip
- Design and test of small prototypes and full scale chips
- Collaborate in the system integration of the readout chips

#### Your profile

The successful candidate should have a degree in electronics, physics or related fields with experience in chip design. Experience in analogue chip design for hybrid pixel detectors would be appreciated. You will work as a teamplayer in a stimulating international environment, giving you excellent opportunities for new initiatives.

#### We offer

Our institution is based on an interdisciplinary, innovative and dynamic collaboration. You will profit from a systematic training on the job, in addition to personal development possibilities and our pronounced vocational training culture. If you wish to optimally combine work and family life or other personal interests, we are able to support you with our modern employment conditions and the on-site infrastructure.

Paul Scherrer Institut, Human Resources Management, Nicole Schubert, Forschungsstrasse 111, 5232 Villigen, PSI, Switzerland. [www.psi.ch](http://www.psi.ch).

For further information please contact Dr Bernd Schmitt, phone +41 56 310 23 14.

Please submit your application online by 31 October 2019 for the position as a Chip Designer (index no. 6114-01).

Accelerators | Photon Science | Particle Physics

Deutsches Elektronen-Synchrotron  
A Research Centre of the Helmholtz Association



For our location in Hamburg we are seeking:

## DESY-Fellowships in experimental particle physics

### DESY

DESY is one of the world's leading research centres for photon science, particle and astroparticle physics as well as accelerator physics. More than 2400 employees work at our two locations Hamburg and Zeuthen in science, technology and administration.

Particle physics and the investigation of the fundamental building blocks of nature and their interactions are at the core of the DESY mission. The lab is among the globally leading research institutions in this field. We take significant responsibility in internationally leading projects, e.g. at CERN and at KEK, and on our campus. We develop detectors and technologies relevant for our experimental activities, and we engage in scientific computing and in the development of future accelerators for particle physics.

### The position

You are invited to take an active role in one or more of the following areas at Hamburg.

- Our involvements at CERN (ATLAS, CMS) and at KEK (Belle II)
- Experimental activities on-site (ALPS II and future on-site experiments)
- Preparations for future particle physics experiments, in particular detector and technology development
- Scientific computing
- Accelerator development

### Requirements

- Ph.D. in physics completed within the last four years
  - Interest in particle physics
  - Expertise relevant for at least one of the areas listed above
- DESY-Fellowships are awarded for a duration of 2 years with the possibility of prolongation by one additional year.

Further informations and a link to the submission system for your application and the references can be found here: [www.desy.de/FellowFH](http://www.desy.de/FellowFH)

Please note that it is the applicants responsibility that all material, including letter of references, reach DESY before the deadline for the application to be considered.

Salary and benefits are commensurate with those of public service organisations in Germany. Classification is based upon qualifications and assigned duties. Handicapped persons will be given preference to other equally qualified applicants. DESY operates flexible work schemes. DESY is an equal opportunity, affirmative action employer and encourages applications from women. Vacant positions at DESY are in general open to part-timework. During each application procedure DESY will assess whether the post can be filled with part-time employees.

We are looking forward to your application via our application system: [www.desy.de/onlineapplication](http://www.desy.de/onlineapplication)

Deutsches Elektronen-Synchrotron DESY  
Human Resources Department | Code: FHFE003/2019  
Notkestraße 85 | 22607 Hamburg Germany  
Phone: +49 40 8998-3392  
<http://www.desy.de/career>

Deadline for applications: 2019/09/30

HELMHOLTZ RESEARCH FOR GRAND CHALLENGES



Karlsruhe Institute of Technology (KIT) – The Research University in the Helmholtz Association creates and imparts knowledge for the society and the environment. It is our goal to make significant contributions to mastering the global challenges of humankind in the fields of energy, mobility, and information. For this, about 9,300 employees of KIT cooperate in a broad range of disciplines in research, academic education, and innovation.

In Division V – Physics and Mathematics, the KIT Department of Physics, invites applications for a

## Professorship (W3) in Experimental Particle Physics

at the Institute of Experimental Particle Physics (ETP) (successor of Prof. Dr. Thomas Müller).

We are looking for an outstanding scientist working in the area of experimental particle physics. We are particularly interested in a scientist who pursues precision measurements and searches for physics beyond the Standard Model at high-energy particle accelerators and initiates new research directions at future international large-scale facilities. The successful applicant is expected to play an active role in coordinated research efforts at KIT.

KIT provides an excellent environment for research in particle and astroparticle physics. The successful candidate will be part of a team of senior scientists who maintain and develop the research in particle physics at KIT. ETP has long-term involvements in the large-scale projects CMS and Belle II. Your participation in, or support of, the evolution of these projects is expected. The infrastructure at ETP currently includes a semiconductor laboratory, workshops and computer clusters. Close ties exist with the Tier-1 computing centre GridKa. Research at ETP is funded by the BMBF, the DFG and the Helmholtz Association.

ETP is part of the KIT Centre Elementary Particle and Astroparticle Physics (KCETA, see [www.kceta.kit.edu](http://www.kceta.kit.edu) for further information). The rich research environment in KCETA includes further large-scale projects such as the Pierre Auger Observatory in Argentina, the IceCube experiment at the South Pole and the KATRIN experiment at KIT. Close collaborations exist with strong theoretical physics groups working on (astro)particle phenomenology. The Karlsruhe School of Elementary Particle and Astroparticle Physics: Science and Technology (KSETA) provides access to an excellent pool of Ph.D. students.

The appointed professor will be part of the ETP board of directors and assume responsibilities in the academic self-administration. The candidate is required to teach at all levels of the undergraduate and graduate curriculum (eventually in German) and to supervise bachelor, master and Ph.D. students. A Habilitation degree or equivalent scientific and teaching qualifications are required.

KIT is pursuing the strategic goal of substantially increasing gender balance and diversity of its faculty. As an equal opportunity employer, KIT explicitly encourages applications from women as well as from all others who will bring additional diversity to the university's research and teaching. KIT provides support for dual career couples and families. Applicants with disabilities will be preferentially considered if suitably qualified. The terms of employment are listed in § 47 Landes Hochschulgesetz (LHG) of the State of Baden-Württemberg.

Qualified candidates should submit before **30 September 2019** a curriculum vitae, list of publications, as well as research and teaching statements to: Dekanat der KIT-Fakultät für Physik, Karlsruher Institut für Technologie (KIT), 76128 Karlsruhe, Germany, preferably by email to [dekanat@physik.kit.edu](mailto:dekanat@physik.kit.edu). For further information about this position please contact Prof. Dr. Margarete Mühleitner, email: [margarete.muehleitner@kit.edu](mailto:margarete.muehleitner@kit.edu), or Prof. Dr. Günther Quast, email: [guenter.quast@kit.edu](mailto:guenter.quast@kit.edu).

KIT – The Research University in the Helmholtz Association

Gain unique insights on the latest  
research and project developments in  
particle physics and related fields

[cerncourier.com](http://cerncourier.com)





edition  
2020

**TWO COURSES**  
**on Particle & Astroparticle Detectors**

Course 1  
**20 JANUARY - 14 FEBRUARY**  
Course 2  
**17 FEBRUARY - 13 MARCH**

**APPLY NOW**  
www.esipap.eu  
esipap@esi-archamps.eu



- Applications are welcome for Master students, PhD students and junior professionals.
- Depending on their academic records, BSc students may also be admitted.
- Short participation available for Professionals !



**Discover what's out there.**



**DATA SCIENTIST / SOFTWARE DEVELOPER**  
**EXCITING CAREERS FOR STEM GRADUATES AND POSTGRADUATES**

Tessella is a data science, analytics and software consultancy that works with global companies at the forefront of science and technology. We are leaders in the field of data science and analytics, helping clients solve their most complex technical challenges by unlocking the power of their data, enabling them to make better-informed business decisions.

Our projects are varied and typically at the cutting-edge of high-tech R&D, for example:

- » Solving computational problems for chemists in drug discovery and development.
- » Modelling and simulating new products for FMCG clients and analysing data to improve processes.
- » Writing algorithms and solving complex mathematical problems to control satellites and radar systems.
- » Solving the computational challenges of oil and gas exploration and production, from reservoir modelling to writing control systems.

We are looking for science, mathematics and engineering graduates and postgraduates to join us. Supported by our extensive training package, you will apply your deep domain knowledge and use a range of skills to create and develop innovative solutions that truly make a difference in the world.

www.tessella.com | jobs@tessella.com



ELI Beamlines research centre in Dolní Břežany is part of pan-European infrastructure ELI (Extreme Light Infrastructure) representing a unique tool of support of scientific excellence in Europe by making available its capacities to the best scientific teams across the world. The aim of ELI Beamlines is to establish the most intensive laser system in the world and to operate it on a long-term basis. Due to ultra-high performances of 10 PW (1 petawatt = 1,000,000,000,000,000 watts) and concentrated intensities of up to 1024 W/cm<sup>2</sup>, we can offer our users a unique source of radiation and beams of accelerated particles. The so called beamlines will enable groundbreaking research in the area of physics and science dealing with materials, but also in biomedicine and laboratory astrophysics and many other fields. ELI Beamlines is part of the Institute of Physics of the Czech Academy of Sciences, and it was open in 2015.

The Institute of Physics of the Czech Academy of Sciences is a holder of the HR Excellence in Research Award. It is awarded by the European Commission to institutions which put significant effort into improving their HR strategy and ensuring professional and ethical working conditions.

**Scientific Data Management Specialist (Software Engineer)**

**Job description:** Your main mission will be to implement solutions for cataloging experimental data and metadata and integrating them into PaNOSC and EO SC. You will collaborate with multiple teams at ELI as well as within PaNOSC project to bring data from their acquisition to publicly accessible web services based on FAIR Data Principles (Findable, Accessible, Interoperable, Reusable).

**Required skills:** university degree in Computer Science, Engineering, Science, or related field • experience with working with scientific data and metadata • experience with setting up and managing databases • experience with development of APIs • experience with programming in Python • good knowledge of Linux/Unix programming environment • proficiency in English

**Desired skills:** experience with machine learning for big data processing • experience with control systems like TANGO • experience in European projects and international collaborations

**We offer:** the opportunity to participate in this unique scientific project • competitive and motivating salary • flexible working hours • nice working environment • career growth • lunch vouchers, pension contribution and 5 sick days • support of leisure time activities

Applications, containing CV, cover letter, contacts of references, and any other material the candidate considers relevant, should be sent to Mrs. Jana Ženíšková, HR specialist (jana.zeniszkova@eli-beams.eu, +420 - 601560322).

Information regarding the personal data processing and access to the personal data at the Institute of Physics of the Czech Academy of Sciences can be found on: <https://www.fzu.cz/en/processing-of-personal-data>



physicsworld  
**careers**

**Career opportunities for those with a background in physics and related subjects**

A bumper-sized book with helpful careers advice, real-life case studies, as well as an extensive employer directory powered by **brightrecruits**

**Download the free Physics World app today!**



Read online at [physicsworld.com/careers](http://physicsworld.com/careers)



# BACKGROUND

Notes and observations from the high-energy physics community

## Accelerators get personal

LEGO® bricks, pop-up books, cakes – all have all been turned into model accelerators or detectors in the name of particle-physics outreach. But a father-and-daughter team from Sydney has taken the idea to a new level. Their Personal Particle Accelerator is a working model that uses computer-controlled electromagnets to power a steel ball around a transparent tube. It started life five years ago when 12-year old Jo Collins was looking for a school project. After several years spent refining and improving the design with her father and others, it's now a kit that can be built at home or school, albeit one that requires "a bit of technical experience with electronics and technology". Numerous experiments can be carried out with the open-source apparatus, such as testing the effects of gravity or friction, and a crowdfunding campaign recently launched on Kickstarter has raised more than AU\$25,000 in pre-orders. This will enable upgrades such as evacuated tubes and options to change the direction of the ball, as in a real accelerator. For those keen to push the boundaries of their wiring and soldering skills, the device even comes in a super-sized version. But what of the linear option?

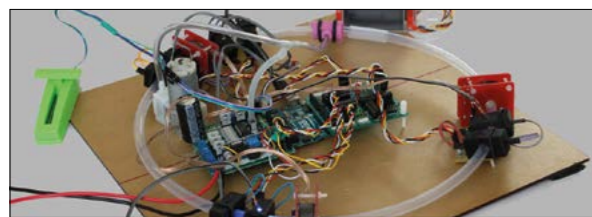

### Media corner

*"Before exploring higher energies, it makes sense to me to build a muon collider, and to clarify the question of the Higgs first. Here we already have a particle that we want to explore."*

Carlo Rubbia calls for courage in deciding the next major collider, in an interview with *Quanta* magazine (7 August).

*"What was not so widely reported, however, is that streamlined imaging of luggage and containers has been achieved, in part, by improvements to the accelerators that provide the electron beams for the scanners."*

Carsten Welsch of the University of Liverpool addressing "What have particle accelerators ever done for us?" in *Physics World* (20 August), following Heathrow airport's installation of new

CT scanners that don't require travelers to separate liquids and gels in their hand luggage.

*"We're going to turn the UK into a kind of supercharged magnet, drawing scientists like iron filings from around the world coming to help push forward projects like this."*

UK prime minister Boris Johnson quoted on *BBC News* (8 August), following a visit to the Culham Centre for Fusion Energy.

*"Scientists are not fools. They know that turmoil is inevitable for many years."*

Andre Geim of the University of Manchester, who shared the 2010 Nobel Prize in Physics for the discovery of graphene, quoted in *The Times* (9 August) following the UK government's announcement of fast-track visa applications for scientists.

### From the archive: October 1976

#### People and people ...

The 1970s saw abiding achievements in areas other than emerging new physics.

At Fermilab, commissioning of the Cancer Therapy Facility CTF made smooth and steady progress. Alan Jones, a CTF technician, is seen (right) positioning his head at the neutron beam port during development. The first therapeutic irradiation took place in September, when a volunteer patient, a woman suffering from cancer of the tongue, received a dose of neutrons. She spent about an hour at the facility, returning several times for further doses.



Meanwhile, Soviet scientists attending a conference on US-USSR cooperation in science, visited several American laboratories including Berkeley, Stanford,



Fermilab and Brookhaven. They are seen above with their hosts during their visit to SLAC. Left to right: back row: O M Rodzianko (US translator), V A Yarba, V Matveev, J S Coleman (ERDA), Keller (SLAC); front row: D F Khokhlova, P A Cherenkov, W K H Panofsky (SLAC), I V Chuvilo (Head of Delegation), V A Vasilyev, A Ts Amatuni, V F Kuleshov.

• Compiled from text on p353 and p355 of *CERN Courier* October 1976.

#### Compiler's note



*In the 1970s, nuclear medicine was in its infancy and east-west geopolitical tension was at its height. Half a century later, cancer patients are being treated with carbon ions in advanced hadron-therapy centres (see p10). But the existential challenges we face need concerted efforts on many fronts – and most of all, peace. The successful collaborative approach taken by the particle-physics community to achieve its goals, testifies to the benefits, often unforeseen, that accrue from global cooperation.*

**>€0.5 billion**

**Cost to develop the estimated 50 million lines of high-energy physics code that have been written, were they outsourced to IT professionals rather than graduate students and postdocs.**

WE ENABLE UNMATCHED DATA ACQUISITION PERFORMANCE. BUY WITH CONFIDENCE FROM A TRUSTED BIG PHYSICS SUPPLIER.



## When Compromise is Not an Option. High-Performance Digitizers for Big Physics Applications

**NEW!**  
**ADQ8-8C**  
8 CHANNELS,  
10-BIT, 1 GSPS

Digitizers from Teledyne SP Devices utilize patented calibration technology, the latest data converters, and state-of-the-art FPGAs in order to achieve an unrivaled combination of high resolution and sampling rate. Their versatility makes them ideal for applications such as beam position monitoring, plasma diagnostics, and more.

Supported features include:

- Up to 10 GSPS sampling rate with 14 bits resolution
- Open FPGA for custom real-time signal processing
- Multiple form factors including MTCA.4, PXIe and PCIe
- Multi-channel synchronization capabilities
- White Rabbit synchronization (MTCA.4 only)
- Peer-to-peer streaming to GPU (PCIe only)
- Application-specific firmware speed up development

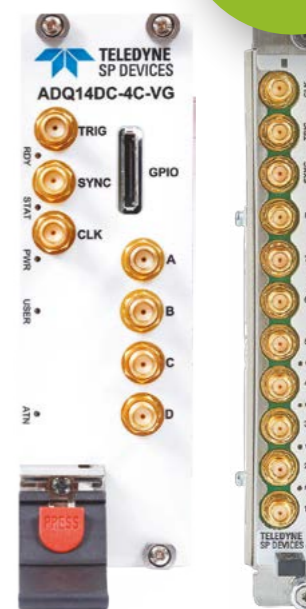

Learn more on our website [www.spdevices.com](http://www.spdevices.com)

**TELEDYNE SP DEVICES**  
Everywhere you look™





**NEW**

# SCI-Compiler

## User Firmware Generator and Compiler for CAEN Programmable Boards



CHECK THIS OUT!



- Block diagram based user firmware generator and compiler
- Automatic VHDL generation starting from logic blocks and virtual instruments
- Automatic generation of drivers, libraries and demo software for Windows, Linux and macOS to implement communication between devices and PC software through USB, ethernet and VME protocol.

### What is SCI-Compiler

We introduce an innovative method to simplify the firmware development.

This method is based on a graphical programming interface consisting of blocks specifically developed for nuclear physics applications.

The SCI-Compiler software allows to develop both purely digital applications, exploiting blocks like scaler, counter, pattern matching, logic analyzer and state machine, and analog processing applications, such as custom multichannel analyzer using charge integration, trapezoidal filter, spectrum and oscilloscope blocks. In addition, the SCI-Compiler software provides the function to read and test the ASICs, enabling the user to develop a sequencer for the ASIC control.

**DT5550W**  
128 Channel SiPM Readout System



### SCI-Compiler supported boards



Multichannel Analog Front-End for SiPM



Programmable Logic Unit



128 Channel DAQ System



32 Channel DAQ System

